

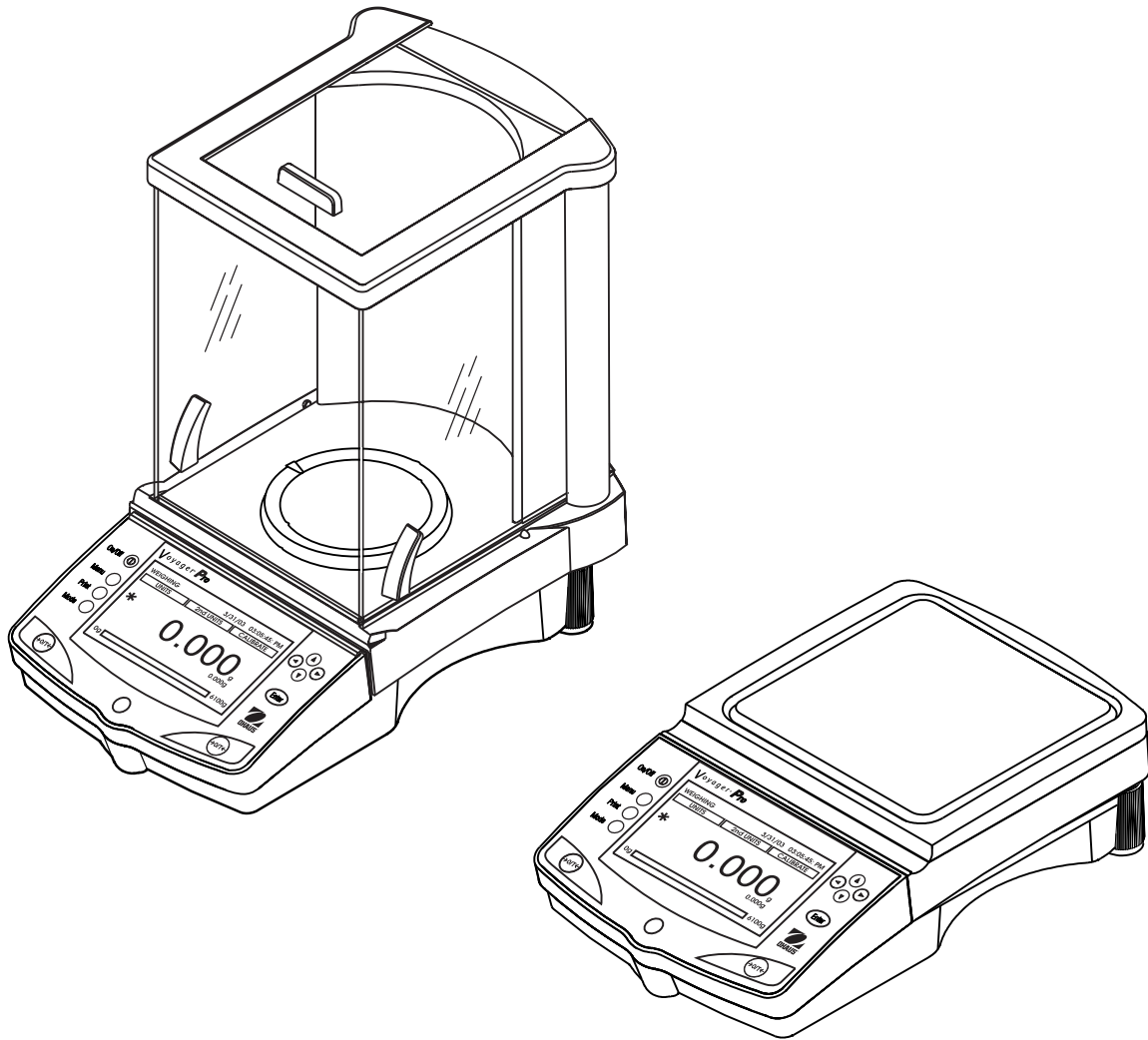

# Voyager<sup>®</sup> Pro Instruction Manual







Declaration of Conformity

The undersigned, representing the following manufacturer

Ohaus Corporation  
 19A Chapin Road  
 PO Box 2033  
 Pine Brook, NJ 07058 USA

hereby declares that the following products are in conformity with the EEC directives listed below (including any and all modifications).  
 Balance models: VP64C, VP64CN, VP64CM, VP114C, VP114CN, VP114CM, VP214C, VP214CN, VP214CM, VP214DC, VP214DCN, VP214DCM, VP213C, VP213CN, VP213CM, VP413C, VP413CN, VP413CM, VP613C, VP413DC, VP413DCN, VP413DCM, VP612C, VP612CN, VP612CM, VP2102C, VP2102CN, VP2102CM, VP4102C, VP4102CN, VP4102CM, VP6102C, VP6102CN, VP6102CM, VP4102DC, VP4102DCN, VP4102DCM, VP4101C, VP4101CN, VP4101CM, VP6101C, VP6101CN, VP6101CM, VP8101C, VP8101CN, VP8101CM

Marked with: Gekennzeichnet mit: Munis de la mention: Contrassegnati con la marcatura: Con el distintivo:	Directive Richtlinie Directive Directiva Direttiva	Standard Norm Norme Norma Norma
	<b>EU 73/23/EEC</b> Low Voltage Niederspannung Basse tension Baja tensión Bassa tensione	<b>IEC 1010 -1:1990 + A1: 92 + A2: 95</b> Safety requirements for electrical equipment for measurement, control and laboratory use – Part 1: General requirements  Sicherheitsbestimmungen für elektrische Meß-, Steuer-, Regel- und Laborgeräte — Teil 1: Allgemeine Anforderungen  Règles de sécurité pour appareils électriques de mesurage, de régulation et de laboratoire – Partie 1: Prescriptions générales  Requisitos de seguridad de equipos eléctricos de medida, control y uso en laboratorio – Parte 1: Requisitos generales  Prescrizioni di sicurezza per apparecchi elettrici di misura, controllo e per utilizzo in laboratorio — Parte 1: Prescrizioni generali
	<b>EU 89/336/EEC</b> Electromagnetic compatibility Elektromagnetische Verträglichkeit Compatibilité électromagnétique Compatibilidad electromagnética Compatibilità elettromagnetica	<b>EN61326: 1997 + A1: 1998</b> Electrical equipment for measurement, control and laboratory use (Class B)  Elektrische Betriebsmittel für Leittechnik und Laboreinsatz —EMV-Anforderungen (Class B)  Matériels électriques de mesure, de commande et de laboratoire — Prescriptions relatives à la CEM (Class B)  Equipo eléctrico de medida, control y uso en laboratorio — Requisitos de compatibilidad electromagnética (Class B)  Apparecchi elettrici di misura, controllo e laboratorio — Prescrizioni di compatibilità elettromagnetica (Class B)
 	<b>EU 90/384</b> NAWI FNSW BFNA PBNA BFNA  xx= year CE affixed	<b>EN45501:1992</b> Non-automatic weighing instruments Nichtautomatische Wiegevorrichtungen Instruments de pesage à fonctionnement non automatique Instrumentos de pesaje de funcionamiento no automático Strumenti per pesare a funzionamento non automatico

**ISO 9001 Registration for Ohaus Corporation.** Ohaus Corporation, USA, was examined and evaluated in 1994 by the Bureau Veritas Quality International, BVQI, and was awarded ISO 9001 registration. This certifies that Ohaus Corporation, USA, has a quality system that conforms with the international standards for quality management and quality assurance (ISO 9000 series). Repeat audits are carried out by BVQI at intervals to check that the quality system is operated in the proper manner.

  
 Ted Xia  
 President  
 Ohaus Corporation  
 Pine Brook, NJ USA  
 Date: July 29, 2003

  
 Urs Müller  
 General Manager  
 Ohaus Europe  
 Greifensee, Switzerland

**Additional Standards**



**CAN/CSA-C22.2 No. 1010.1-92; UL Std. No. 3101-1**

Safety requirements for Electrical Equip. for measurement, Control and Laboratory Use, Part 1; General Requirements



**FCC, Part 15, class A** Emission



**AS/NZS4251.1**  
N13123

**AS/NZS4252.1** Emission and Immunity

Note: This equipment has been tested and found to comply with the limits for a Class A digital device, pursuant to Part 15 of the FCC Rules. These limits are designed to provide reasonable protection against harmful interference when the equipment is operated in a commercial environment. This equipment generates, uses, and can radiate radio frequency energy and, if not installed and used in accordance with the instruction manual, may cause harmful interference to radio communications. Operation of this equipment in a residential area is likely to cause harmful interference in which case the user will be required to correct the interference at his own expense.

This Class A digital apparatus complies with Canadian ICES-003.

Cet appareil numérique de la classe A est conforme à la norme NMB-003 du Canada

## TABLE OF CONTENTS

1.	INTRODUCTION .....	EN-3
1.1	Description .....	EN-3
1.2	Features .....	EN-3
1.3	Safety Precautions .....	EN-3
2.	INSTALLATION .....	EN-3
2.1	Unpacking .....	EN-3
2.2	Installing Components .....	EN-4
2.2.1	Platform Installation .....	EN-4
2.2.2	Windshield Installation .....	EN-4
2.2.3	Weigh Below Preparation .....	EN-4
2.3.	Selecting the Location .....	EN-5
2.3.1	Balance Location .....	EN-5
2.3.2	Leveling the Balance .....	EN-5
2.4	Connecting Power and Communications .....	EN-6
2.4.1	AC Adapter Installation .....	EN-6
2.4.2	RS232 Interface .....	EN-6
2.4.3	Initial Calibration .....	EN-7
3.	OPERATION .....	EN-8
3.1	Overview of Controls .....	EN-8
3.2	Overview of Display Indicator .....	EN-10
3.3	Menu .....	EN-11
3.3.1	Menu Structure .....	EN-11
3.3.2	Navigation .....	EN-11
3.3.3	Turning On the Balance .....	EN-11
3.4	Applications .....	EN-12
3.4.1	Weighing .....	EN-12
3.4.2	Parts Counting .....	EN-13
3.4.3	Animal Weighing .....	EN-17
3.4.4	Percent Weighing .....	EN-19
3.4.5	Check Weighing .....	EN-20
3.4.6	Filling .....	EN-21
3.4.7	Gross/Net/Tare Weighing .....	EN-22
3.4.8	Differential Weighing .....	EN-23
3.4.9	Formulation .....	EN-25
3.4.10	Statistics .....	EN-26
3.4.11	Statistical Quality Control (SQC) .....	EN-29
3.4.12	Density .....	EN-31
3.4.13	Pipette .....	EN-37

## TABLE OF CONTENTS (Cont.)

3.5	Balance Settings .....	EN-40
3.5.1	Calibration .....	EN-40
3.5.2	Balance Options .....	EN-41
3.5.3	Readout .....	EN-42
3.5.4	Application Modes .....	EN-42
3.5.5	Units .....	EN-42
3.5.6	Interface .....	EN-44
3.5.7	Print Options .....	EN-44
3.5.8	GLP Print Options .....	EN-44
3.5.9	Library .....	EN-45
3.5.10	Lockout .....	EN-46
3.5.11	Factory reset .....	EN-46
3.9.12	LFT Legal for Trade .....	EN-47
3.5.13	Hardware Lock Switch .....	EN-47
3.5.14	Sealing the Balance .....	EN-47
3.6	Printing Data .....	EN-47
4.	CARE AND MAINTENANCE .....	EN-48
4.1	Cleaning .....	EN-48
4.2	Troubleshooting .....	EN-48
4.3	Error Codes List .....	EN-49
4.4	Service Information .....	EN-50
4.5	Replacement Parts .....	EN-50
4.6	Accessories .....	EN-50
5.	TECHNICAL DATA .....	EN-51
5.1	RS232 Commands .....	EN-51
5.2	Specifications .....	EN-52

INDEX

# 1. INTRODUCTION

## 1.1 Description

Thank you for deciding to purchase a Voyager® Pro Balance from Ohaus. VoyagerPro's software design allows direct access to 12 application modes and all menus. The backlit dot matrix display, is capable of displaying either limited or multiple data fields at each application. Voyager Pro's standard AutoCal™ automatically calibrates the balance due to temperature changes that may affect calibration. Panel controls and soft key functions on the display clearly indicate functions and data. Operation is extremely simplified, you enter a menu, select an item, modify the item according to menu selections and exit.

Capacities from 62 grams to 8,100 grams are available.

To ensure you make full use of the possibilities offered by your Voyager Pro balance, we advise you to read through these operating instructions.

## 1.2 Features

- Ready to weigh without complicated setup
- 3 soft keys are application mode specific.
- Operating languages include English, Spanish, French, German and Italian.
- Simplified menu navigation and balance setup.
- Capacity Bar guide and Fill bar guide.
- Flexibility to display either simple weighing results or more advanced results including piece count, average piece weight, sample size, tare weight, weight, under and over.
- Dot Matrix display with backlight
- Weighing, Parts Counting, Animal Weighing, Percent Weighing, Check Weighing, Gross/Net/Tare Weighing and Filling.
- Advanced weighing applications: Statistics, SQC, Formulation, Pipette, Differential Weighing.
- Library storage.
- Auto Calibration

## 1.3 Safety Precautions

Please follow the safety precautions as listed.

### CAUTION:

- Do not operate the balance around corrosive fumes.
- Only use the adapter provided with the balance.
- Do not try to service the Voyager Pro balance.

# 2. INSTALLATION

## 2.1 Unpacking

Open the package and remove the instrument and the accessories. Check the completeness of the delivery. The following accessories are part of the standard equipment of your new Voyager Pro balance.

<b>Pan 3.5", 9cm Round</b> - Analytical 62g, 110g, 162g, 210g, 210/100g
<b>Pan 4.7", 12cm Round</b> - Precision 210g 410g, 610g, 410/100g
<b>Pan 6.8", 17.2cm Square (0.01 g units)</b> - Precision 610g, 1500g, 2100g, 4100g, 6100g, 4100/1000g
<b>Pan 6", 15.2cm Square (0.1 g units)</b> - Precision 6100g, 4100g, 8100g
<b>Draft Shield</b> - Analytical 62g, 110g, 162g, 210g, 210/100g
<b>Draft Shield (0.001g units)</b> - Precision 210g 410g, 610g, 410/100g
<b>Wind Shield (0.01g Units)</b> - Precision 610g, 2100g, 4100g, 6100g, 4100/1000g

The following items are supplied with all balances:

AC Power Adapter, Instruction Manual, Warranty Card, In Use Cover

- Remove packing material from the instrument.
- Check the instrument for transport damage. Immediately inform your Ohaus dealer if you have complaints or parts are missing.
- Store all parts of the packaging. This packaging guarantees the best possible protection for the transport of your instrument.

## 2.2 Installing Components

### 2.2.1 Platform Installation

Balances are shipped with the pan not installed. On balances equipped with a draft shield, slide open the side door and insert the pan into the center hole.

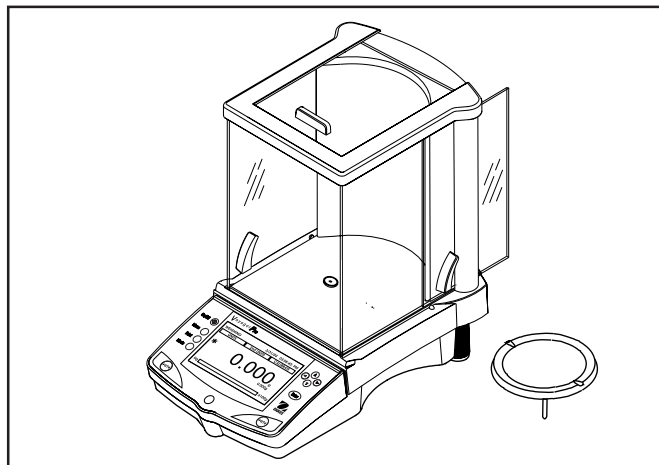

### 2.2.2 Windshield Installation

On 610 g to 6100 g balances with 0.01 g resolution, a windshield is required to reduce the possibility of air currents from disturbing the pan. When the windshield is in place, air currents are deflected up over the pan. Make sure the windshield is firmly snapped into place.

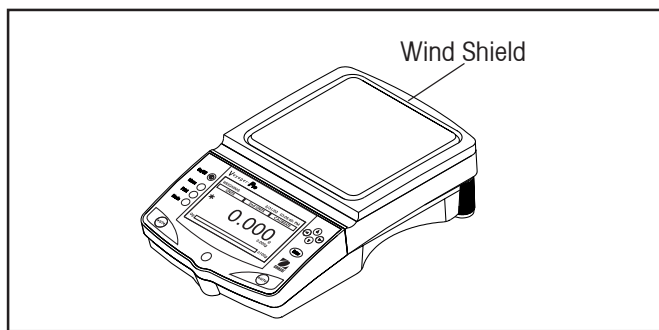

### 2.2.3 Weigh Below Preparation

The Voyager Pro balance is equipped with a weigh below hook at the bottom of the balance. To use this feature, remove the protective cover underneath the balance. See illustration for location. The balance can be supported using lab jacks or any other convenient method. Make sure the balance is level and secure. Apply power and operate the balance. Attach items to be weighed to the hook underneath the balance.

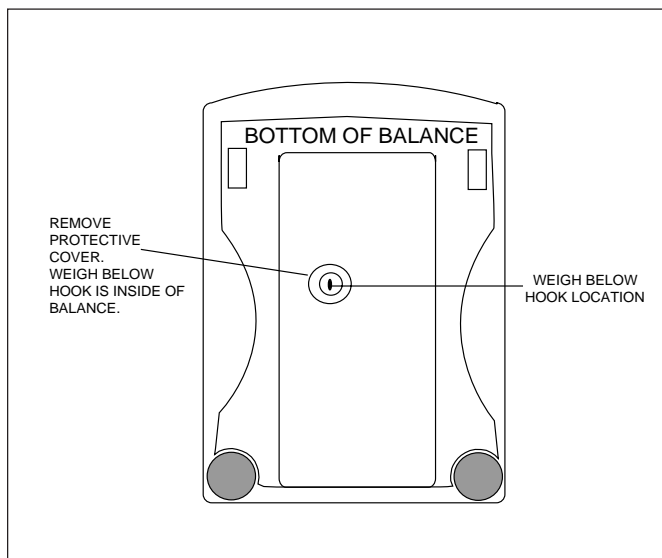



## 2.3 Selecting the Location

### 2.3.1 Balance Location

The balance should always be used in an environment which is free from excessive air currents, corrosives, vibration, and temperature or humidity extremes. These factors will affect displayed weight readings.

DO NOT install the balance:

- Next to open windows or doors causing drafts or rapid temperature changes.
- Near air conditioning or heat vents.
- Near vibrating, rotating or reciprocating equipment.
- Near magnetic fields or equipment that generates magnetic fields.
- On an unlevel work surface.
- Allow sufficient space around the instrument for ease of operation and keep away from radiating heat sources.

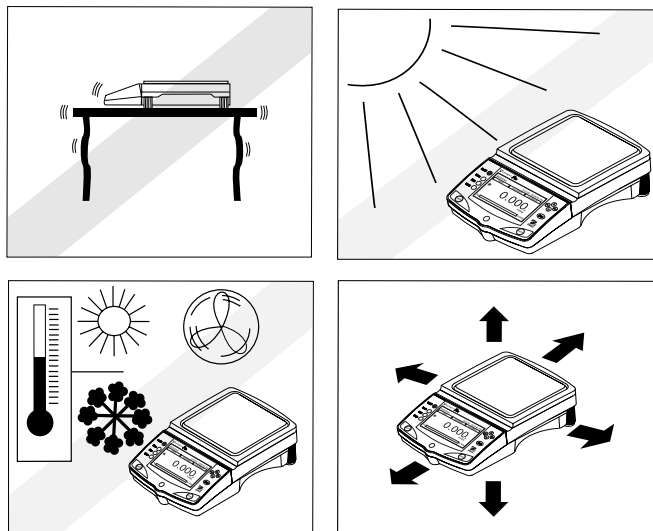

### 2.3.2 Leveling the Balance

Exact horizontal positioning and stable installation are prerequisites for repeatable results. To compensate for small irregularities or inclinations at the location, the instrument can be leveled.

For exact horizontal positioning, the balance is equipped with a level indicator located at the front on the control panel and two leveling feet located at the rear of the balance.

Position the balance in the intended operating location. Adjust the leveling feet at the rear of the balance until the air bubble in the indicator is centered.

**NOTE:** The instrument should be leveled each time its location is changed.

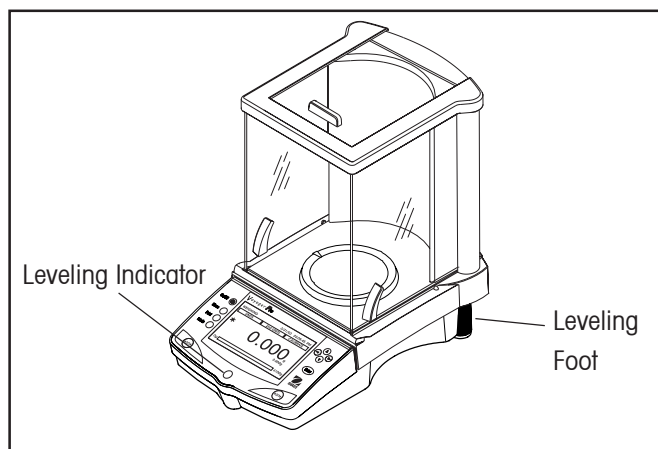
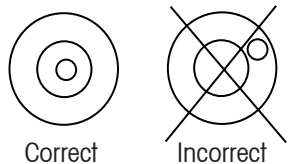

## 2.4 Connecting Power and Communications

### 2.4.1 AC Adapter Installation

Connect the AC Adapter supplied to the three pin connector located at the rear of the balance.

The balance is now ready for operation.

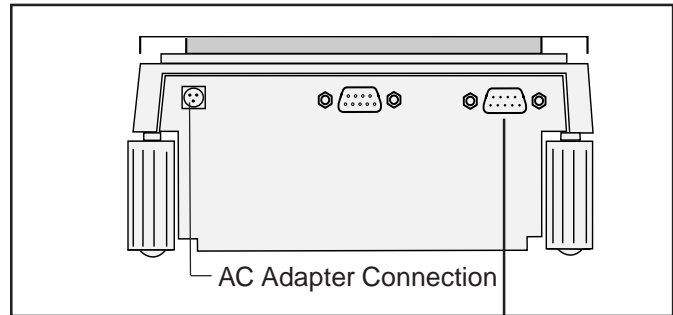

Rear of Balance

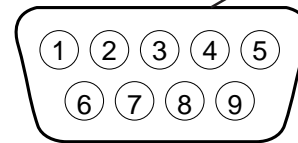

Male Connector

### 2.4.2 RS232 Interface

Voyager Pro balances are equipped with a bidirectional RS232 compatible interface for communication with serial printers and computers. When the balance is connected directly to a printer, displayed data can be output at any time by simply pressing the **Print** button, or by using the Auto Print feature. Connecting the balance to a computer enables you to operate the balance from the computer, as well as receive data such as displayed weight, weighing mode, stability status, etc.

The following sections describe the hardware and software provided with the balance

#### Hardware

On the rear of the balance, the right-hand, 9-pin male subminiature "D" connector is provided for interfacing to other devices. The pinout and pin connections are shown in the adjacent illustration. Refer to paragraph 3.5.6 for setup.

The balance is equipped with hardware handshaking, it will not output any data unless pin 5 (CTS) is held in a high state (+3 to +15 V dc). Interfaces not utilizing the CTS handshake may tie pin 5 to pin 6 to defeat it.

#### Output Formats

Data output can be initiated in one of three ways: 1) By pressing PRINT; 2) Using the Auto Print feature; 3) Sending a print command ("P") from a computer.

Additional information is located in Section 5, Technical Data which contains the RS232 Command Table.

1	N/C
2	Data Out (TXD)
3	Data In (RXD)
4	N/C
5	Clear To Send (CTS)
6	Data Terminal Ready (DTR)
7	Ground
8	Request To Send (RTS)
9	N/C

## 2.4.3 Initial Calibration

### Calibrating from the Weighing Screen

When the balance is first turned on, three soft keys appear on the weighing screen. The CALIBRATE soft key is highlighted. This permits calibration immediately without entering the CALIBRATION menu.

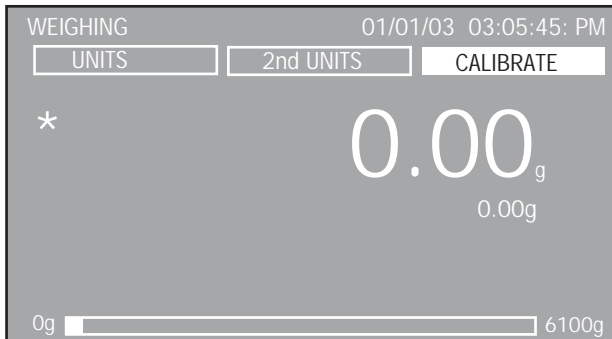

Press the **Enter** button with the CALIBRATE soft key highlighted.

## 3 OPERATION

### 3.1 Overview of Controls

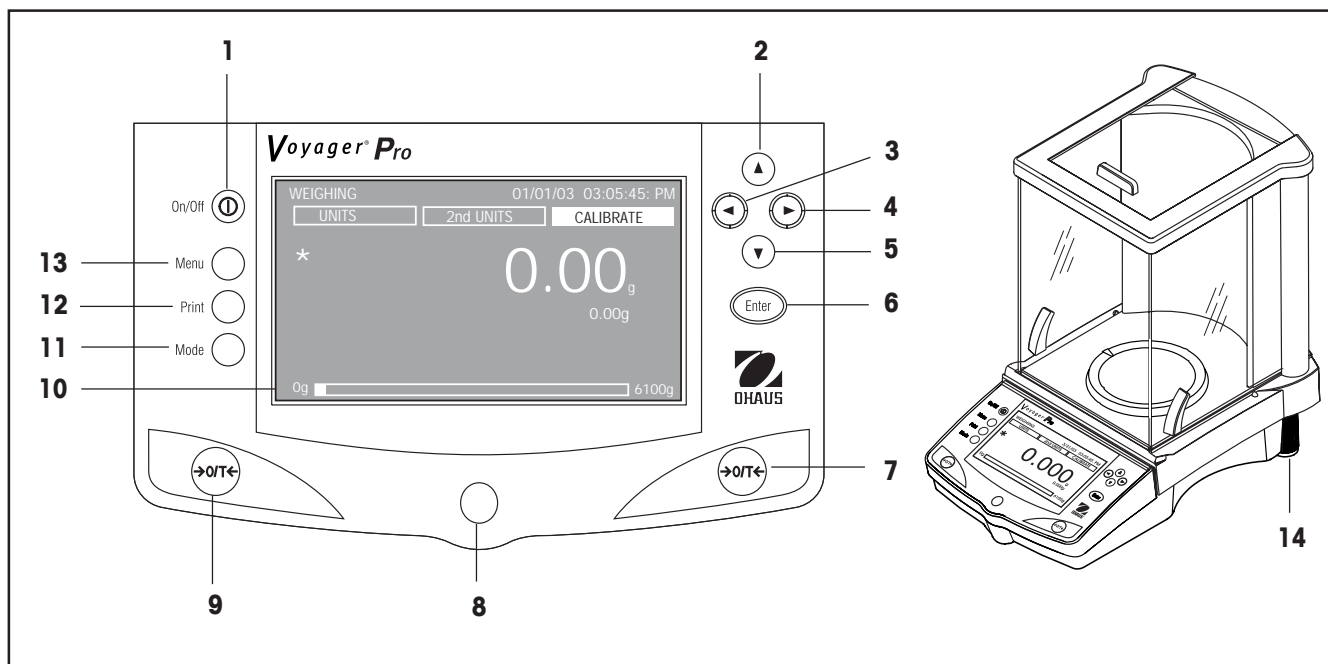

No.	Designation	Function
1	⏻	Power On/ Off button.
2	▲ button	When pressed in Menu mode, single press moves menu selection bar in an up direction and highlights the activated field or changes the settings of a selected field in increasing order.  When at an alphanumeric field, then the number or letter is incremented.
3	◀ button	When pressed in Menu mode, single press moves the cursor within a alphanumeric field to the left (example date 07/02/2003). Selection does not wrap at end.  In application mode, single press moves to the next soft key selection to the left.
4	▶ button	When pressed in Menu mode, single press moves the cursor within a alphanumeric field to the right (example date 07/02/2003). Selection does not wrap at end.  In application mode, single press moves to the next soft key selection to the right.

No.	Designation	Function
5	 button	<p>When pressed In Menu mode, single press moves menu selection bar in a down direction and highlights the selected field or changes the settings of a selected field in decreasing order.</p> <p>When at an alphanumeric field, then the number or letter is decremented.</p>
6	<b>Enter</b> button	<p>When pressed in application modes, functions as an "Enter" button to accept Soft-key selection.</p> <p>When pressed in menu, functions as an "Accept" button for accepting and saving parameter of selected items.</p>
7 & 9	<b>&gt;0/T&lt;</b> buttons	When pressed, performs tare function or zero function.
8	Spirit Level	Provides a leveling indication for the balance.
10	LCD Display	Backlit LCD display provides all necessary indications for operation.
11	<b>Mode</b> button	When pressed, causes the balance to cycle through all active application modes.
12	<b>Print</b> button	When pressed in any application mode, causes a print function to occur.
13	<b>Menu</b> button	When pressed in any application mode, will bring up the Menu screen. Pressing the button within a Menu screen will return to the application mode.
14	Feet	Two adjustable feet used to level the balance.

### 3.2 Overview of Display Indicator

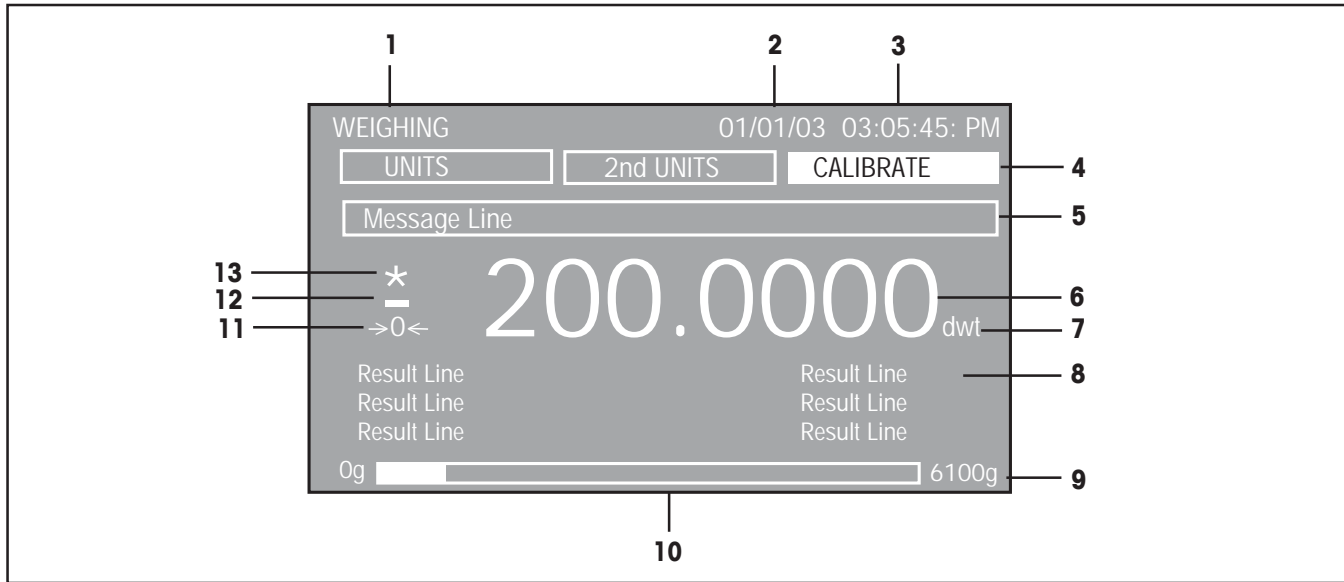

No.	Designation	Function
1	Application	Indicates the active application by function or library name.
2	Date	Indicates current date when properly set.
3	Time	Indicates current time when properly set.
4	Soft Keys	Three Soft-keys are displayed in the upper display area. Depending on the application mode selected, the functionality changes. A Soft-key can be selected by using the left and right arrow buttons. Pressing the <b>Enter</b> button on a highlighted soft-key will activate the function.
5	Message Line	Contains instructional messages.
6	Numerical Display	Indicates primary weight/load.
7	Unit of measure	Indicates active unit of measure.
8	Result Lines 1-6	Six lines that contain balance results.
9	Capacity	Indicates full balance capacity.
10	Bar Graph	Shaded area indicates capacity used for, under, accept, over for check weighing application, or target values for filling application.
11	->0<-	Indicates center of zero (only active in legal for trade).
12	-	Indicates negative value.
13	*	Stability indicator.

## 3.3 Menu

### 3.3.1 Menu Structure

The Voyager Pro balance utilizes a menu structure that permits entering various menus by using a dedicated **Menu** button. Pressing the **Menu** button allows access to additional sub menus. See illustration below.

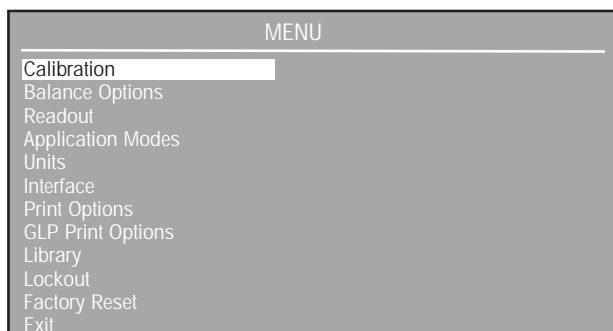

### 3.3.2 Navigation

When the balance is first turned on, the main weighing screen is displayed. To enter the menu and to change parameters, the following controls are used:

**Menu** button - When pressed, enters the Menu.

**Enter** button- When pressed, accepts the menu field selections.

▲ - Scrolls up through the menus.

▼ - Scrolls down through the menus.

◀ - Moves the cursor within the field to the left.

▶ - Moves the cursor within the field to the right.

There are two ways to exit the Menu; one is to scroll to Exit and press the **Enter** button, the other is to press the **Menu** button. All changes will be saved.

To select a highlighted menu, press the **Enter** button. Each menu item contains a display that allows setting balance parameters to individual requirements. These are described in detail in section 3.5 Balance Settings.

Section 3.5.1 describes Calibration procedures and section 3.4 describes the Applications.

### 3.3.3 Turning on the Balance

The Voyager Pro balance is ready to operate after the installation procedures are performed. When the balance is first turned on and it completes its checks, it can be used to weigh or tare materials without setting the menus.

It is recommended that you read this manual carefully and set the balance to operate to your specific applications before using.

#### Power On/Off

To turn the balance ON, press the **On/Off** button. To turn OFF, press the button again.

#### Stabilization

Before initially using the balance, allow time for it to adjust to its new environment. The balance only requires to be plugged in to warm up.

Recommended warm up period is twenty (20) minutes. Analytical Class I balances require at least 2 hours.

The internal circuits of the balance are powered whenever it is plugged into a power source.

### 3.4 Applications

The Voyager Pro balance contains Weighing, Parts Counting, Animal Weighing, Percent Weighing, Check Weighing, G/N/T, Statistics, SQC, Pipette, Formulation, Differential Weighing and Filling applications. Before using any of these applications, they must be turned on first before they can be accessed. A choice can be made to turn on or off as many of these applications as required. The balance default setting has the weighing mode turned on and all other modes are off.

To select applications to be turned on or off, press the **Menu** button and using the arrow buttons, scroll to Application Modes, then press the **Enter** button.

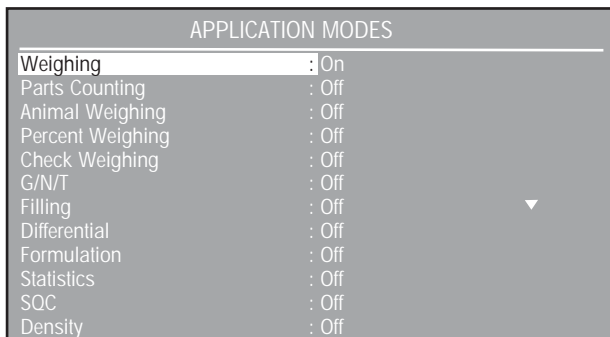
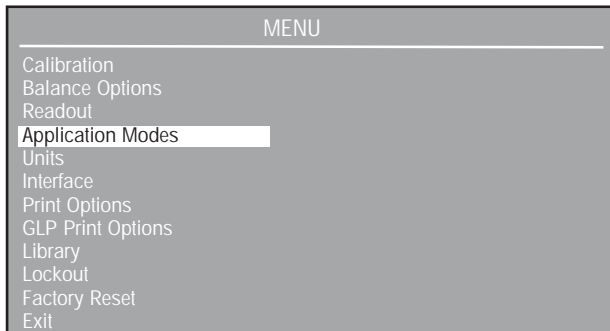

By pressing the **Enter** button and using the arrow buttons, each item on the Application Modes screen can be turned on or off. When finished, press the **Menu** button, the balance returns to weighing mode. All settings are saved.

To use any of the modes that have been turned on, press the **Mode** button repeatedly to cycle through all of the application modes.

#### 3.4.1 Weighing

The Voyager Pro balance is shipped with grams only enabled. The balance can be used immediately after calibration has been performed. When the balance is to be used with other units of measure, the desired unit must be enabled.

##### USE

Zero the balance. Place objects or material to be weighed on the pan. Example indicates a 200 gram weight on a 6100g balance.

Wait for the stability indicator to appear before reading the weight.

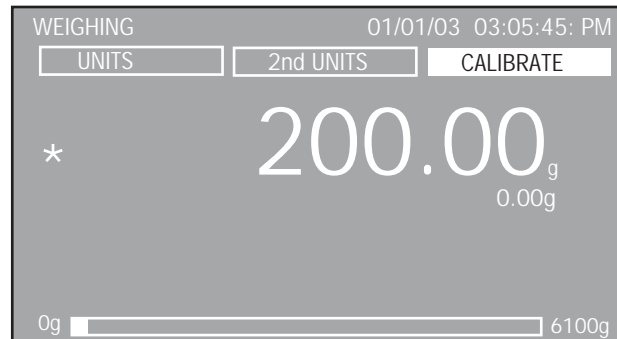

##### WEIGHING WITH A CONTAINER

With no load on the pan, zero the balance.

Place an empty container on the pan. Its weight is displayed. Tare the balance. The container's weight is stored in memory.

Add material to the container. As material is added, its net weight is displayed.

Removing the container and material from the pan will cause the balance to display the container's weight as a negative number. The tared container weight will remain in memory until the balance is zeroed again or the balance is turned off.



## ADJUSTMENTS

Three soft-keys at the top of the display screen labeled UNITS, 2nd UNITS and CALIBRATE are accessed by using the arrow buttons and selected by pressing the **Enter** button.

### CALIBRATE

When the CALIBRATE soft key is highlighted, and the **Enter** button is pressed, calibration can be performed.

### 2ND UNITS

When 2nd UNITS is highlighted, each press of the **Enter** button cycles through the measuring units that are turned On in the Units menu. The last option when cycling through the units is Off.

### UNITS

When UNITS is selected and highlighted, each press of the **Enter** button cycles through the measuring units that are On and will appear adjacent to the large numerals.

## 3.4.2 Parts Counting

Three different Parts Counting modes can be selected, Count, Check or Fill in the Parts Counting Setup. Each mode is described separately.

### USE

#### PARTS COUNTING

In the Parts Counting mode, the balance displays the quantity of parts you place on the pan. Since the balance determines the quantity based on the average weight of a single part, all parts must be reasonably uniform in weight.

The balance has a default setting of 10 pieces. This permits starting parts counting immediately without setting up the balance. The following display indicates the first time operation of parts counting.

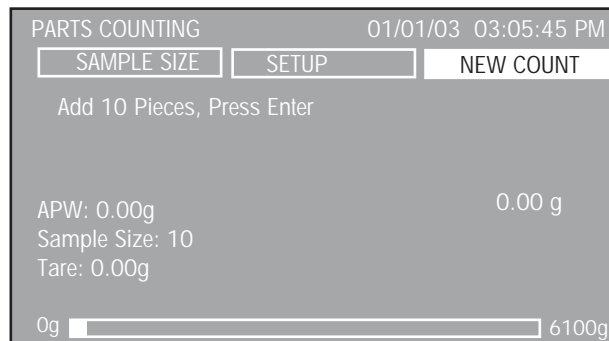

Tare the balance if required. With the NEW COUNT soft key highlighted, press the **Enter** button. Place 10 pieces on the pan as instructed by the blinking text on the display. Press the **Enter** button.

The display now indicates the Average Piece Weight (APW) and the sample size.

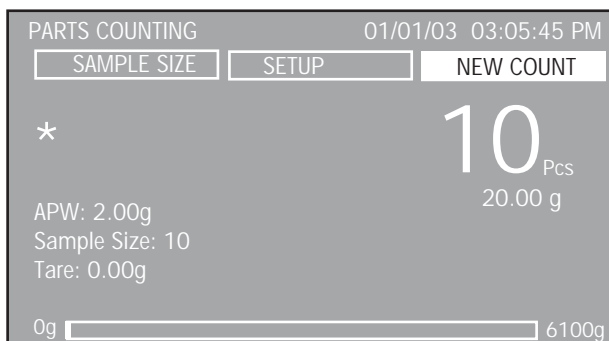

Place parts to be counted on the pan. Balance displays number of pieces.

### ADJUSTMENTS

The Parts Counting display contains three soft keys at the top of the screen SAMPLE SIZE, SETUP and NEW COUNT.

#### NEW COUNT

When NEW COUNT soft key is selected, follow the screen instructions "Add 10 Pieces, Press Enter ". After pressing the **Enter** button, the balance calculates the APW and the display indicates the number of pieces.

#### SETUP

Select the SETUP soft key and press the **Enter** button. The PARTS COUNTING SETUP is shown.

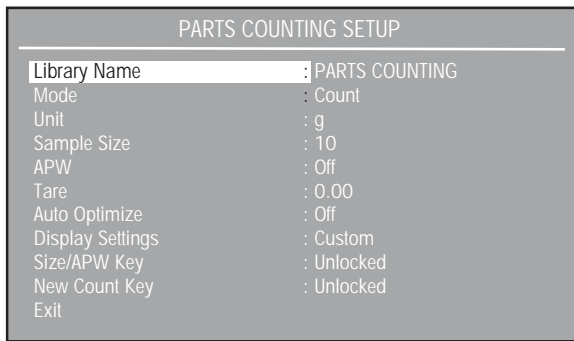

Using the arrow keys and **Enter** button, each item on the display can be entered and modified as required. The following information describes each entry on the screen.

Library Name:

Allows storage and recovery of parameters and results. When a library is recovered, the library name will replace the application name in the application mode screen. The library name has maximum of 18 characters.

Mode: Count, Check, Fill (default is Count)

Three different modes are available, Count, Check or Fill. The applications for Check and Fill are described in detail after this section.

Unit: g, kg, etc... (default is g)

Allows the selection of all activated units.

Sample Size : 0-99 (default is 10)

Defines the amount of pieces used to calculate APW (average piece weight). Setting the sample size will force the APW field to Off and change the APW soft key to SAMPLE SIZE.

APW: 0-999999999 (default is Off)

Defines the average piece weight. Setting the APW will force the Sample Size field to Off and change the SAMPLE SIZE soft key to APW.

Tare: 0-99999999 (default is 0)

Defines the weight of the container being used.

Auto Optimize: On,Off (default is Off)

Selecting Auto Optimize On will recalculate the APW value automatically during the parts counting process up to double the amount of parts.

For higher quantities, the APW will not be recalculated. During the auto optimization process, the message "Auto Optimizing, Please wait" will be displayed in the message bar on the screen.

Display Settings: Custom, Default (default is Default)

Selecting Display Settings to Custom will bring up the DISPLAY SETTINGS screen that will allow individual display items to be turned on or off. Selecting Exit will return balance to previous screen.

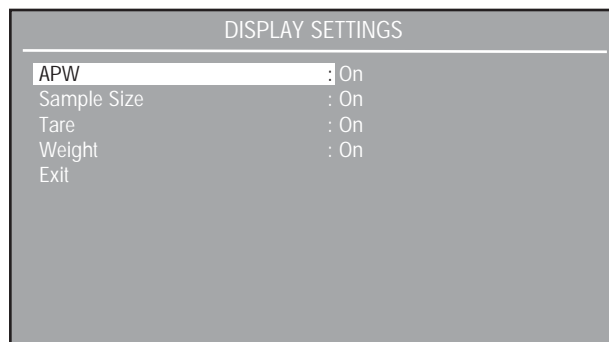

Size/APW Key: Unlocked, Locked (default is Unlocked)

Allows locking and unlocking the soft key function in the Parts Counting screen. If locked, the message "Key Is Locked" will be displayed in the message bar.

New Count Key: Unlocked, Locked (default is Unlocked)

Allows locking and unlocking the soft key function in the Parts Counting screen. If locked, the message "Key Is Locked" will be displayed in the message bar.

Exit:

When selected, balance returns to the Parts Counting Mode.

SAMPLE SIZE/APW

With SAMPLE SIZE soft key highlighted,press the **Enter** button. The PARTS COUNTING display is shown with the value of the sample size highlighted. Using the arrow buttons and the **Enter** button, the sample size value can be changed.

After the **Enter** button is pressed, and a new sample size has been entered, remove the sample and place parts to be counted on the balance using the new sample size.

APW

With the APW soft key highlighted, press the **Enter** button. The APW is highlighted at the lower left of the screen. Using the arrow buttons and the **Enter** button, the APW value can be changed.

## USE

### PARTS COUNTING-CHECK

This feature permits establishing a set quantity of pieces as a criteria for similar items that can be quickly checked against the sample. In the Parts Counting Check mode, the displayed data includes, present count (Pcs), APW, Sample Size, Tare, Weight and a bar graph indicating UNDER, ACCEPT (blinking) and OVER.

Enter the PARTS COUNTING SETUP menu and change Mode to Check.

The balance is now in the PC CHECK mode.

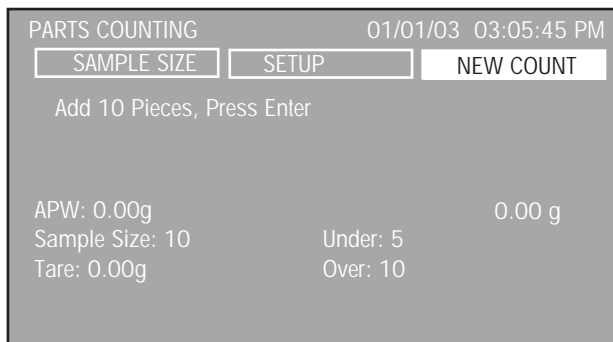

The balance indicates to add 10 pieces and has an Under value of 5 and an Over value of 10 set up as default values and an average piece weight has not been set. Place 10 pieces on the pan and press the **Enter** button.

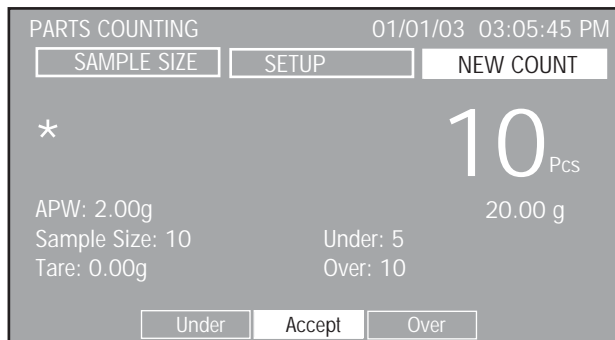

An average piece weight has been set by placing the pieces on the pan. To use the PC Check, the Over and Under values must be set as well as other display setup parameters. Refer to adjustments and set the balance parameters to fit specific requirements.

## ADJUSTMENTS

The PC Check display contains three soft keys at the top of the screen SAMPLE SIZE, SETUP and NEW COUNT.

### NEW COUNT

When NEW COUNT soft key is selected, follow the screen instructions "Add 10 Pieces, Press Enter ". After pressing the **Enter** button, the balance calculates the APW and the display indicates the number of pieces.

### SETUP

Using the left arrow key, select SETUP soft key and press the **Enter** button. The PARTS COUNTING SETUP is shown.

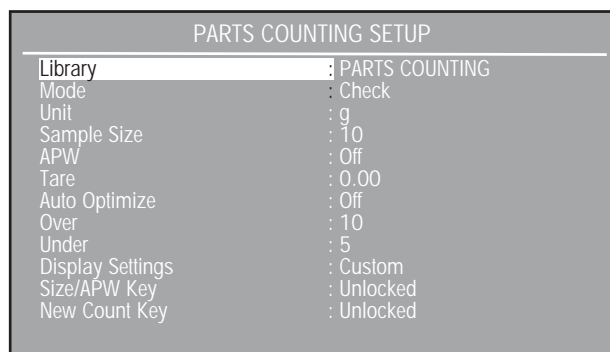

Two additional entries have been added to the PARTS COUNTING SETUP, they are Over and Under. Refer to the Adjustments section of parts counting for a description of all other settings.

Over 10: 0-9999 (default is 10)

Defines the over limit in pieces.

Under 5: 0-9999 (default is 5)

Defines the under limit in pieces.

Display Settings: Custom, Default (default is Default)

Selecting Display Settings to Custom will bring up the DISPLAY SETTINGS screen that will allow individual display items to be turned on or off. Sample Size, Tare, Weight are described under parts counting Display Settings.

Three new entries Weight, Over and Under appear on this screen. Selecting Exit will return balance to previous screen.

Weight: On,Off (default is On)  
Can be turned on or off.

Over: On, Off (default is On)  
Can be turned on or off.

Under: On, Off (default is On)  
Can be turned on or off.

**SAMPLE SIZE/APW**

Select SAMPLE SIZE soft key and enter the sample size desired.

**APW**

With the APW soft key highlighted, press the **Enter** button. The APW is highlighted at the lower left of the screen. Using the arrow buttons and the **Enter** button, the APW value can be changed. Follow screen instructions and place sample on pan.

Remove the sample and place items on pan. In the following example, the sample size was 10, the APW was 5.00g, the under value was set at 99 and the over value was set at 101. The acceptable value was 100 pieces.

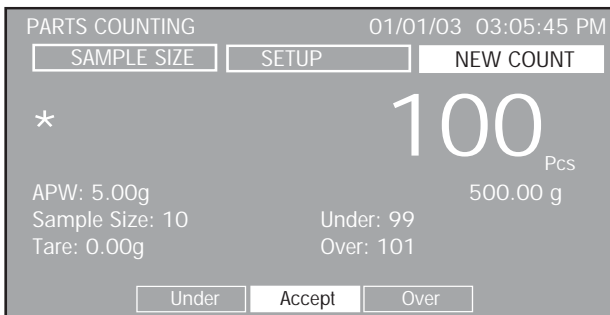

**USE**

**PARTS COUNTING-FILL**

This feature permits establishing a set quantity of pieces that can be shown as a percentage when pieces are added. A split bar display indicates 0% to 90% on the first bar and 90% to 110% on the second bar.

Enter the PARTS COUNTING SETUP menu and change Mode to Fill.

The balance is now in the PC FILLING mode.

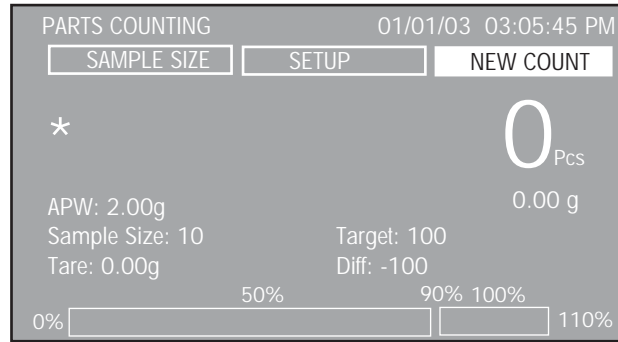

**NOTE:** The values appearing on the screen initially are from previous entries in parts counting.

Placing an item on the pan at this time will only respond to the previous settings for sample size and APW.

To use PC FILLING, the sample size and other parameters must be set first. Refer to adjustments and set the balance parameters to fit specific requirements.

**ADJUSTMENTS**

The PC FILLING display contains three soft keys at the top of the screen SAMPLE SIZE, SETUP and NEW COUNT.

**NEW COUNT**

When NEW COUNT soft key is selected, follow the screen instructions "Add 10 Pieces, Press Enter" is displayed After pressing the **Enter** button, the balance calculates the APW and the display indicates the number of pieces.

**SETUP**

Select SETUP soft key and press the **Enter** button. The PARTS COUNTING SETUP is shown.

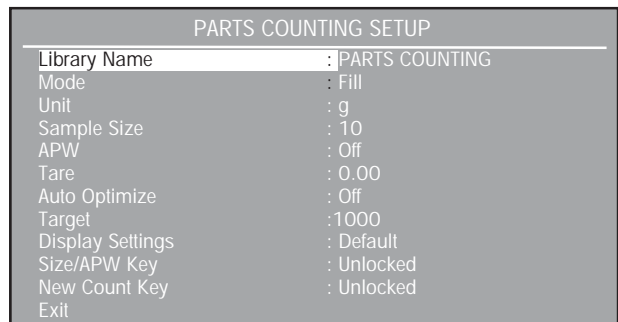

One additional entry has been added to the PARTS COUNTING SETUP, that is Target. Refer to the Adjustments section of parts counting for a description of all other settings.

Target: 0-9999 (default is 1000)

Defines the target pieces for the 100% limit.

Display Settings: Custom, Default (default is Default)

Allows Display Settings to be set to default or custom. If Display Settings is set to custom, information on the result lines of the Parts Counting mode can be individually turned on or off. If Display Setting is set to default, all the information is turned on.

Two new entries Target and Difference appear on this screen. Selecting Exit will return balance to previous screen.

Target: On, Off (default is On)

Can be turned on or off.

Difference: On, Off (default is On)

Can be turned on or off.

**SAMPLE SIZE/APW**

Select SAMPLE SIZE soft key and enter the sample size desired.

**APW**

With the APW soft key highlighted, press the **Enter** button. The APW is highlighted at the lower left of the screen. Using the arrow buttons and the **Enter** button, the APW value can be changed. Follow screen instructions and place sample on pan.

Remove the sample and add items on pan until 100% is highlighted at the bottom of the screen as shown. In the following example, the sample size was 10, the APW was 2.00g, the Target value was set at 100 pieces.

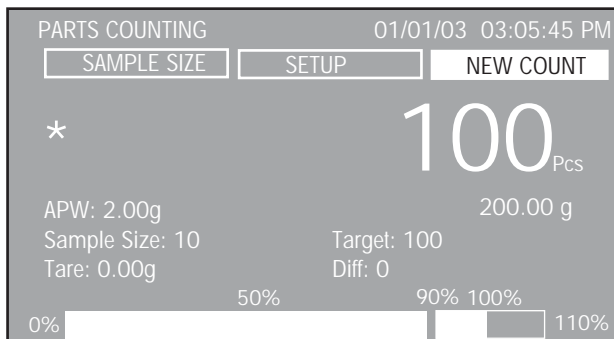

### 3.4.3 Animal Weighing

Animal weighing permits you to weigh small animals and filters out animal movements. Choices of manual, semi automatic and automatic operation is possible.

The display data includes the filtered weight of the animal in selected unit of measurement, and unfiltered weight of the animal in 2nd unit of measurement, filter level, mode of operation and a bar graph indicating present used capacity of the balance.

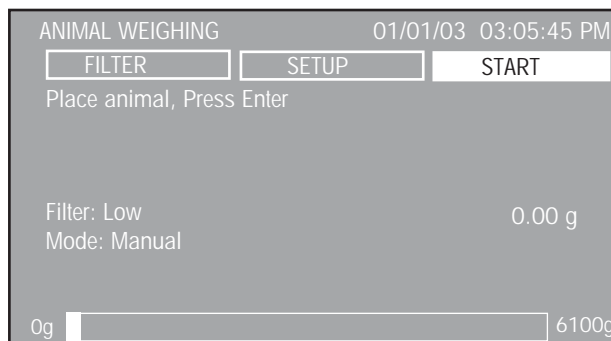

**USE**

**ANIMAL WEIGHING**

Place the animal on the pan. With the START soft key highlighted, press the **Enter** button. The display performs a countdown to average out the weight. The weight is indicated as shown and remains on the display.

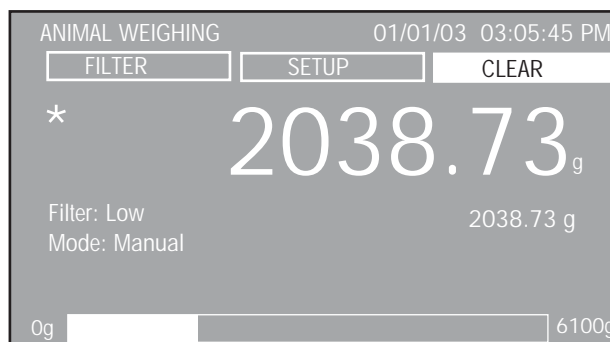

Remove the animal from the pan. With the CLEAR soft key highlighted, press the **Enter** button to clear the weight. The balance is now ready for another measurement. To change the mode of operation from manual to semi automatic or automatic and change filtering levels, refer to Adjustments.

## ADJUSTMENTS

The ANIMAL WEIGHING display contains three soft keys at the top of the screen FILTER, SETUP and START/CLEAR .

### START/CLEAR

Select the START soft key and press the enter button to start the animal weighing process. The soft key is changed to CLEAR and allows the weight to be cleared when the Enter button is pressed.

### SETUP

Select SETUP soft key and press the **Enter** button. The ANIMAL WEIGHING SETUP display is shown.

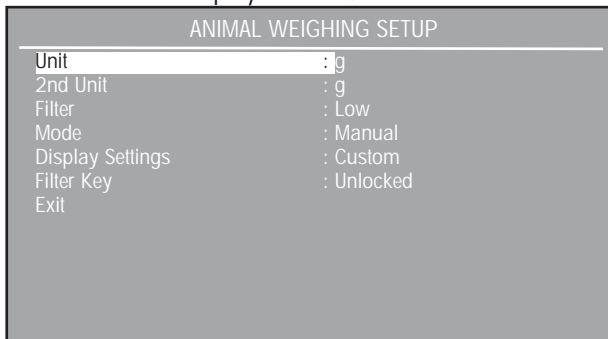

Unit: g, kg, etc...(default is g)

Allows the selection of all activated units.

2nd Unit: g, kg, etc...(default is g)

Allows the selection of all activated units.

Filter: Low, Medium, High (default is Low)

Can be set to one of three filtering levels. A higher level filter will provide more accurate measurement.

Mode: Manual, Semi, Auto (default is Manual)

One of three modes can be set.

### Manual Mode

Weighing process starts manually. After placing animal on pan with soft key START highlighted, press the **Enter** button. Screen display retains reading and is manually cleared by pressing the **Enter** button when soft key CLEAR is highlighted.

### Semi Automatic mode

Weighing process starts automatically as soon as the animal is placed on the pan. When the animal is removed, the display retains the weight reading. The balance must be cleared manually by pressing the **Enter** button.

### Automatic Mode

Weighing process starts automatically as soon as the animal is placed on the pan. The weight is displayed until the animal is removed. The balance is ready for another animal weighing.

Display Settings: Custom, Default (default is Default)

Allows Display Settings to be set to default or custom. If Display Settings is set to custom, information on the result lines of the Animal weighing mode can be individually turned on or off. If Display Setting is set to default, all the information is turned on.

Filter Key: Locked, Unlocked (default is Unlocked)

This feature allows to lock or unlock the Soft key function.

### Exit

When selected, returns to Animal Weighing mode.

### FILTER

Select FILTER soft key and press the **Enter** button. The display is shown with the Filter: Low highlighted. Pressing the up or down arrow buttons, either Low, Medium or High can be selected, then press the Enter button. Low is the default setting. Display is shown. After selection is made, the screen display returns to an Animal Weighing Mode. A higher filter level will provide a more accurate measurement.

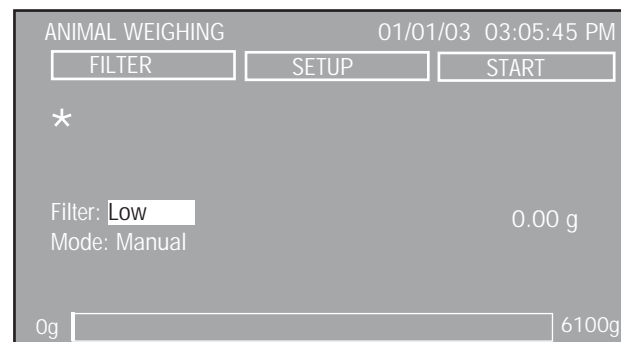

### 3.4.4 Percent Weighing

Percent weighing allows placing a reference load on the balance, then viewing other loads as a percentage of the reference. The load placed on the pan as a reference is displayed as 100%. Subsequent loads are displayed as a percentage of the reference. The maximum limit is the capacity of the balance. The minimum limit is 100d. The display data includes reference weight in unit of measurement, difference value in percent, difference value in measuring unit and a bar graph indicating present used capacity of the balance.

The reference weight is removed and a second weight is placed on the pan. The example illustrates a 50 g weight.

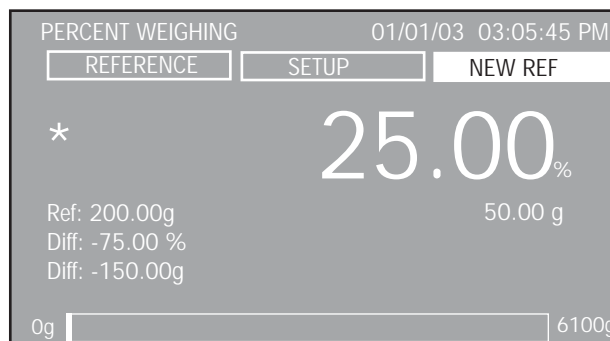
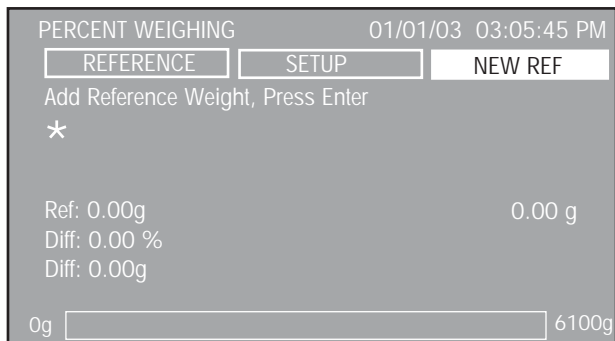

#### ADJUSTMENTS

The PERCENT WEIGHING display contains three soft keys at the top of the screen REFERENCE, SETUP and NEW REF.

#### NEW REF

When NEW REF soft key is selected, follow the screen instructions "Add Reference Weight, Press Enter". This establishes a new reference weight.

#### SETUP

Select SETUP soft key and press the **Enter** button. The PERCENT WEIGHING SETUP display is shown.

#### USE

##### PERCENT WEIGHING

With the NEW REF soft key highlighted, press the **Enter** button. Place the reference weight on the pan and press the **Enter** button again. The sample shown indicates a 200g weight was placed on the pan.

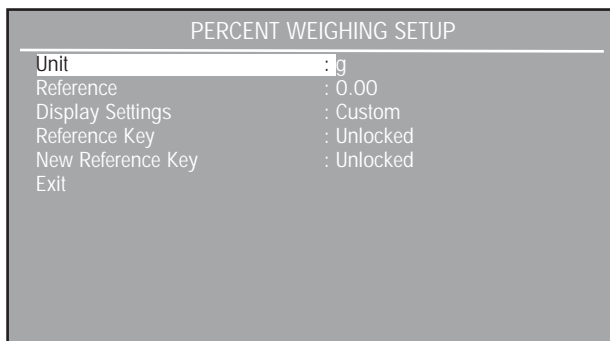
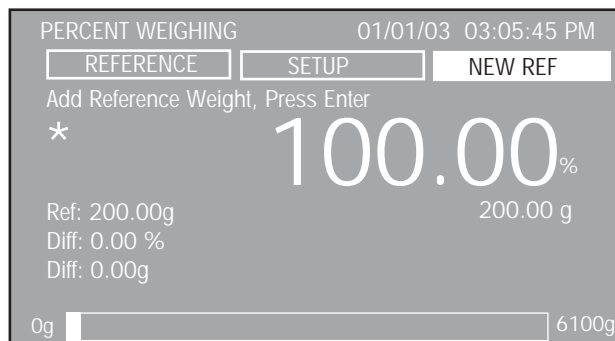

Unit: g, kg, etc...(default g).

Allows the selection of all activated units.

Reference: 0-99999999 (default is 10)

Defines the reference weight at 100%.

Display Settings: Custom, Default (default is Default)

Allows Display Settings to be set to default or custom. If Display Settings is set to custom, information on the result lines of the Percent Weighing mode can be individually turned on or off. If Display Setting is set to default, all the information is turned on.

Reference Key: Locked, Unlocked (default is Unlocked)

Allows locking or unlocking the REFERENCE soft key in the percent Weighing screen. Message "Key is locked" when Locked is selected.

New Reference Key: Locked, Unlocked (default is Unlocked)

Allows locking or unlocking the NEW REF soft key in the Percent Weighing screen. Message "Key is locked" when Locked is selected.

Exit:

When selected, balance returns to the Percent Weighing Mode.

**REFERENCE**

Select REFERENCE soft key and press the **Enter** button. The display screen changes with Ref field highlighted. Reference weight can be specified.

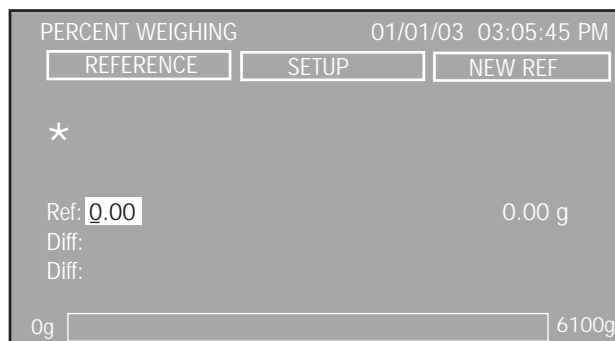

**3.4.5 Check Weighing**

Check weighing is used when items are checked against preset balance parameters. This feature permits you to weigh an item, set balance parameters such as the over weight, target weight and under weight. A bar graph at the bottom of the Check Weighing screen indicates UNDER, ACCEPT and OVER for items being checked.

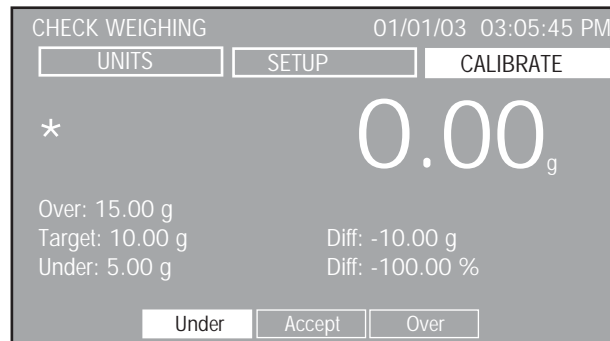

**USE**

**CHECK WEIGHING**

Before using the Check Weighing feature, the Over, Target and Under limits must be set.

**ADJUSTMENTS**

The CHECK WEIGHING display contains three soft keys at the top of the screen UNITS, SETUP and CALIBRATE.

**CALIBRATE**

When the CALIBRATE soft key is highlighted, and the **Enter** button is pressed, calibration can be performed.

**SETUP**

Select the SETUP soft key and press the Enter button. The CHECK WEIGHING SETUP display is shown.

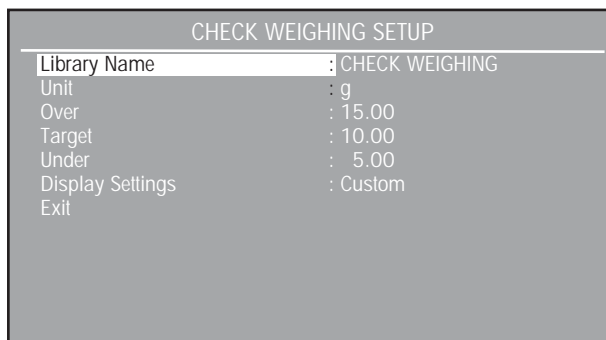



Library Name:

Allows storage and recovery of parameters and results. When a library is recovered, the library name will replace the application name in the application mode screen. The library name has maximum of 18 characters.

Unit: g, kg, etc...(default is g)

Allows the selection of all activated units.

Over: 0-99999999 (default is 15)

Defines over limit value.

Target: 0-99999999 (default is 10).

Defines target value.

Under: 0-99999999 (default is 5)

Defines under limit value.

Display Settings: Custom, Default (default is Default)

Allows Display Settings to be set to default or custom. If Display Settings is set to custom, information on the result lines of the Check Weighing mode can be individually turned on or off. If Display Setting is set to default, all the information is turned on.

Reading allows a choice of either weight readings to be displayed in large numeral or message that displays OVER, ACCEPT and UNDER in large letters. Display below indicates message format.

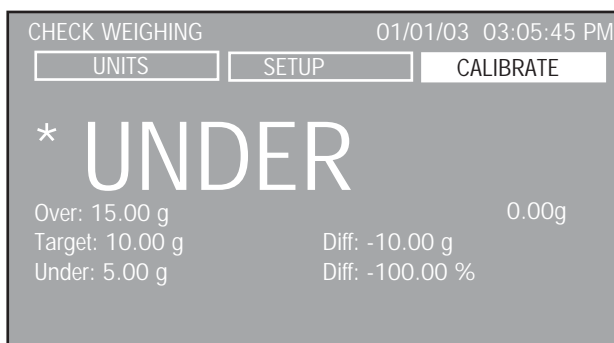

Exit:

When selected, returns to Check Weighing mode.

UNITS

When the UNITS soft key is highlighted, each press of the **Enter** button cycles through the measuring units that are On.

### 3.4.6 Filling

Filling permits entering a target reference weight. Material can be placed on the pan and by monitoring the Difference weight and the bar display, an accurate fill can be achieved. A split bar display indicates 0% to 90% on the first bar and 90% to 110% on the second bar.

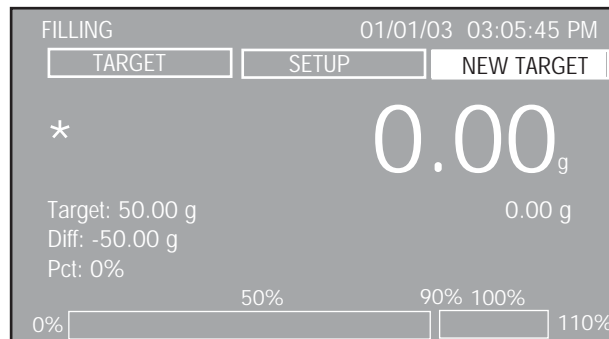

#### USE

##### FILLING

A sample (target weight) is placed on the pan and the Enter button is pressed. The balance stores this weight as shown on the display as Target. The sample is removed from the pan and the material is added to the pan. The display provides Target Weight, Difference weight, Percentage and the split bar at the bottom of the screen displays the percentage of the sample compared against the target weight. When a container is used, zero the balance before placing the actual sample on the pan. See Adjustments to set other balance parameters.

#### ADJUSTMENTS

The FILLING display contains three soft keys at the top of the screen TARGET, SETUP and NEW TARGET.

##### NEW TARGET

With the NEW TARGET soft key highlighted, press the Enter button. Follow display instructions to "Add Target Weight, Press Enter". This establishes a new target weight and is displayed on the screen.

##### SETUP

When SETUP soft Key is highlighted, press the **Enter** button. The FILLING SETUP display is shown.

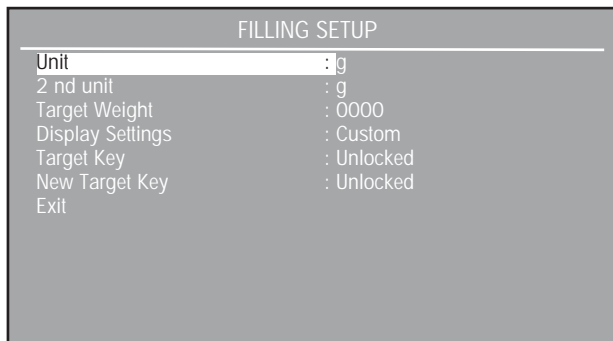

Units: g, kg, etc...(default is g)

Allows the selection of all activated units.

2nd UNITS: g, kg, etc...(default is g)

Allows the selection of all activated units.

Target Weight: 0-99999999 (default is 0)

Allows entering a specific target filling weight.

Display Settings: Custom, Default (default is Default)

Allows Display Settings to be set to default or custom. If Display Settings is set to custom, information on the result lines of the Filling mode can be individually turned on or off. If Display Setting is set to default, all the information is turned on.

Target Key: Locked, Unlocked (default is Unlocked)

This feature allows to lock or unlock the soft key function.

New Target Key: Locked, Unlocked (default is Unlocked)

This feature allows to lock or unlock the soft key function.

Exit:

When selected, balance returns to the Filling Mode.

**TARGET**

With the TARGET soft key highlighted, press the **Enter** button.

The FILLING display is shown with the value of the Target highlighted. Using the arrow buttons and the **Enter** button, the Target value can be changed.

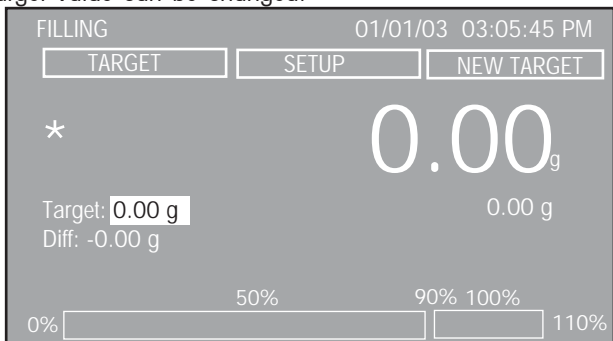

**3.4.7 Gross / Net / Tare Weighing**

Gross/Net/Tare (G/N/T) application allows to display Gross (sample plus container weight), NET (sample weight) and TARE (container weight) simultaneously.

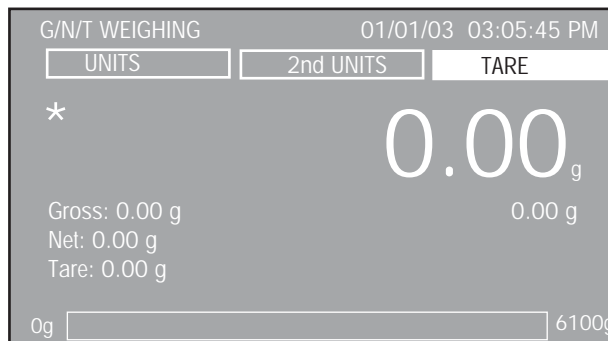

**USE**

**G/N/T WEIGHING**

Press the **O/T** button to zero the balance. In this application, the **O/T** button functions as a Zero and not as a Tare.

Place a container on the pan. With the TARE soft key highlighted, press the Enter button. The container's weight is stored in memory in the balance. Place the material in the container. The balance immediately displays the Gross, Net and Tare weights. The net weight is displayed as large numerals. Example shown represents a container weight of 50g and material of 200g. The gross weight is displayed as 250g. Before a new container is used, zero the balance by using the O/T button.

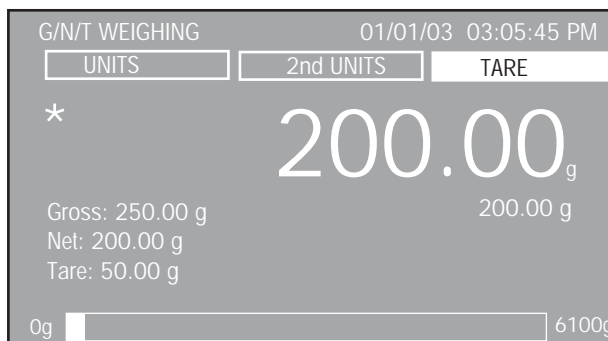

**ADJUSTMENTS**

The G/N/T WEIGHING display contains three soft keys at the top of the screen UNITS, 2nd UNITS and TARE.

**TARE**

When the TARE soft key is selected, pressing the **Enter** button will store the current display reading as the tare value.

**2nd UNITS**

When 2nd UNITS soft key is highlighted, each press of the **Enter** button changes the measuring units that are On and will appear under the large numerals. The last option when cycling through the units is Off.

**UNITS**

When the UNITS soft key is highlighted, each press of the **Enter** button cycles through all active measuring units on the Gross, Net and Tare displays.

### 3.4.8 Differential Weighing

Differential weighing stores tare and weight values so samples can be dried or processed and the difference in weight calculated at a later time. Up to 80 samples can be stored. The balance has the capability to work with one or two different containers or no container at all. Samples can be added to the library or extracted by name using the previously stored data.

#### USE

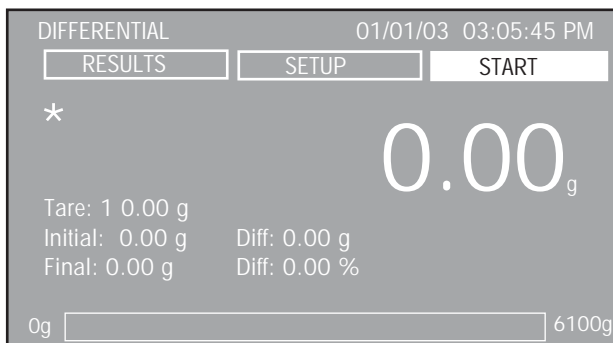

Before using the Differential Weighing feature, the Differential Setup should be reviewed. Highlight the SETUP soft key and press the **Enter** button. Assign a Library Name. Review the settings and change as necessary.

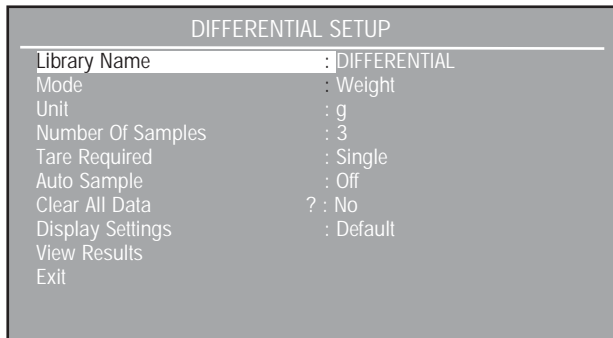

With the START key highlighted, press the **Enter** button. Follow the instructions on the screen and place the first container on the pan and press **Enter**. The START key changes to ACCEPT. Continue until all containers have been weighed. The following screen is displayed indicating the container weights.

Tare Wt	Init Wt	Tare Wt	Final Wt
00.00	0.00	0.00	0.00
00.00	0.00	0.00	0.00
00.00	0.00	0.00	0.00

Sample # 1

Continue   Resample   Delete

With CONTINUE highlighted, press the **Enter** button and follow the screen instructions and add the Initial samples. During this mode, the first screen now contains an EDIT soft key. The EDIT soft key permits entering any Initial or Final sample and rerun.

The screen shown above will now indicate the initial sample weights. At this point, you can select any one of the samples and with the RESAMPLE soft key highlighted and perform a resample.

With the DELETE soft key highlighted, any one sample can be selected and deleted. With CONTINUE highlighted, press the **Enter** button and follow the screen instructions and add the Final samples.

After the last Final sample is entered, the screen above indicates all tare weights, Initial weights and Final weights. With CONTINUE highlighted, pressing the **Enter** button brings up one final screen that contains the Sample #, Initial Weight, Final Weight, Weight Difference and Totals.

All test samples and results can be reviewed by entering Differential Setup and selecting the Library Name. On the first screen, select the RESULTS soft key, press the **Enter** button and the test results are displayed. A total of 80 samples can be stored.

## ADJUSTMENTS

### START/ACCEPT

When the START key is selected, pressing the **Enter** button will start differential weighing application. The screen displays "Place Initial Container X, Press Enter" message and the Differential Weighing process has started. When a new process starts all the data from previous Differential Weighing is erased. At this point, the soft key has changed into an ACCEPT key. When the ACCEPT key is selected, the weight value has been accepted as valid data.

### SETUP

When executed, the DIFFERENTIAL WEIGHING SETUP screen will be displayed.

### EDIT

When executed, an edit screen will display that will allow an user to re-sample a sample weight, or to delete an undesirable sample, or to continue.

#### Library Name:

Allows storage and recovery of parameters and results. When a library is recovered, the library name will replace the application name in the application mode screen. The library name has maximum of 8 characters.

#### Mode: Weight, Percent, % Retention (default is Weight)

Allows the selection of the various calculations in the final results.

#### Units: g, kg, etc...(default is g)

Allows the selection of all activated units.

#### Number of Samples: xx (default is 10)

Allows manual entry for number of samples. Only integer values up to 80 are valid.

#### Total Weight: xxx.xx (default is 10.00)

Retention Mode only, allows manual entry for the Total Weight value. Total Weight has to be less than the balance capacity.

#### Tare Required: Off, Single, Dual (default is Single)

Allows selection of Tare Required. When Off is selected, the balance will not prompt for container. When Single is selected, the balance will prompt for the initial container weight. When Dual is selected, the balance will prompt for the initial container weight and final container weight.

#### Auto Sample: Off, On (default is Off)

Allows Auto Sample to be turned on or off. When Auto Sample is turned on, the Differential Weighing process is automatic.

#### Clear All Data: No, Yes (default is No)

All the data from the Differential Weighing process will be erased when Yes is selected.

#### Display settings: Custom/Default (default is Default)

Allows Display Settings to be set to default or custom. If Display Settings is set to custom, information on the result lines of the Differential Weighing mode can be individually turned on or off. If Display Setting is set to default, all the information is turned on.

#### View Results:

Allows the calculated results of the Differential Weighing process to be viewed.

#### Exit:

In the sub menu, will return to the previous menu.

In the main men, will return to the last application mode.

### 3.4.9 Formulation

Formulations can be named and have from 2 to 10 components specified. Names are limited to 18 characters. Once named, they may be recalled and used at any time. Each component of a given formulation can be specified as to its weight or percentage. Each element of a formulation is shown on a dual bar graph as a percentage and displays the desired weight. Thus, each component may be placed on the pan until 100% is indicated.

#### USE

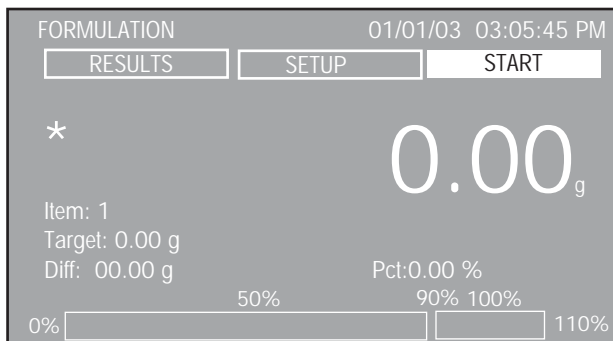

Before using the Formulation feature, the Formulation Setup should be reviewed. Highlight the SETUP soft key and press the **Enter** button. Assign a Library Name. Review the settings and change as necessary. Enter the Mode type, Weight or Percent. Enter the number of Items.

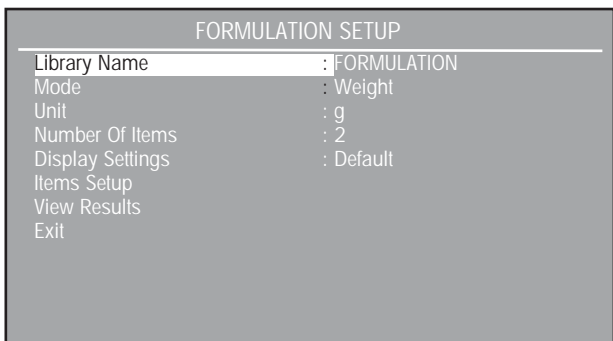

Exit the Formulation Setup. The initial screen appears with the name of the formulation appearing at the upper left-hand corner of the screen.

Place a container on the pan and press the **>0/T<** button to tare the container weight.

With the START key highlighted, press the **Enter** button. Follow the instructions on the screen. The START key changes to ACCEPT.

Add the first component to the container. The dual bar graph at the bottom of the screen indicates the percentage of the component added. The target weight, difference and percent are also displayed. Add each component until the specified Target weight is reached (100%). When adding an individual component, make sure the balance has stabilized and indicates the specified weight. Continue until all components have been added.

The next screen automatically appears and indicates the Target, Result and Difference weights of each component of the formula as well as the totals. Pressing the **PRINT** button will send the screen results to an externally connected printer or computer.

Press the **Enter** button to exit and return to the starting screen. Results of any formulation may be displayed by selecting the RESULTS soft key at the top of the screen. The actual formulation is selected by entering the FORMULA SETUP screen and scrolling through the Library Names.

To start a new formulation, repeat the entire process.

#### ADJUSTMENTS

##### START/ACCEPT

When the START key is selected, pressing the **Enter** button will start formulation application. The screen displays "Add Item "name field", Press Enter" message and the Formulation process has started. When a new process starts, all the data from previous Formulation is erased. At this point, the soft key has changed into an ACCEPT key. When the ACCEPT key is selected, the weight value has been accepted as valid data.

##### SETUP

When selected, the FORMULA SETUP screen will be displayed.

##### RESULTS

When selected, a screen will display all calculated results.

##### Library Name:

Allows storage and recovery of parameters and results.

When a library is recovered, the library name will replace the application name in the application mode screen. The library name has maximum of 18 characters.

Mode: Weight, Percent (default is Weight)

Allows the selection of the various calculations in the final results.

Unit: g, kg, etc... (default is g)

Allows the selection of all activated units.

Number of Items: xx (default is 2)

Allows manual entry for number of items. Only integer values up to 10 are valid.

Target Weight: xxx.xx (default is 5.00)

Allows manual entry for the Target Weight value. Target Weight has to be less than the balance capacity.

Display settings: Custom/ Default (default is Default)

Allows Display Settings to be set to default or custom. If Display Settings is set to custom, information on the result lines of the Formulation mode can be individually turned on or off. If Display Setting is set to default, all the information is turned on.

Item Setup:

Displays a setup menu that will allow a name and a value to be assigned to each item.

With Items Setup selected, specify the names for each component of the formula (limit 9 characters) and either the weights or percentages.

ITEMS SETUP	
Item Name 1	: Item 1
Item Name 2	: Item 2
Item Weight 1	: 0.00
Item Weight 2	: 0.00
Exit	

View Results:

Allows the calculated results of the Formulation process to be viewed.

Exit:

In the sub menu, will return to the previous menu.

In the main men, will return to the last application mode.

### 3.4.10 Statistics

Statistics are used when it is desired to compare a number of samples and examine the relative deviation of the samples along with other statistical data. A minimum of three samples is required in this program. Statistics contains menu options which include: number of samples, maximum, minimum, difference, sum, mean, standard deviation, relative deviation, auto sample, and auto print. Most of these can be set on or off except sample size which can be set for a particular number.

When a printer or computer is connected to the balance, all statistical information can be observed and printed. WEIGHING, ANIMAL WEIGHING, CHECK WEIGHING and FILLING are the functions for providing Statistical Data.

#### USE

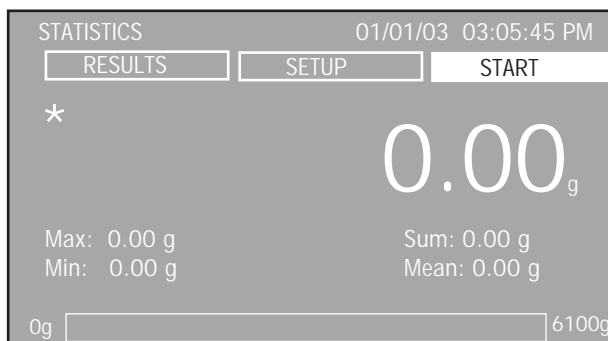

(Used for Weighing and Animal Weighing)

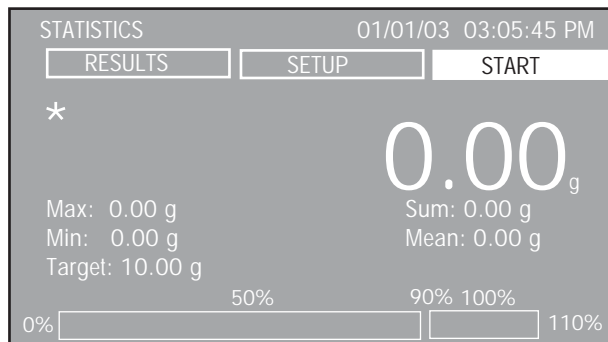

(Used for Filling)

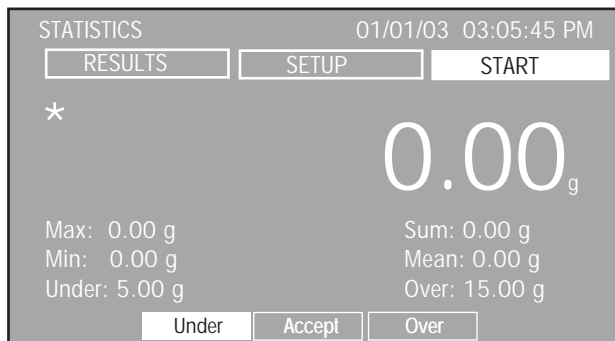

(Used for Check Weighing)

Before using the Statistics feature, the Statistics Setup should be reviewed. Highlight the SETUP soft key and press the **Enter** button. Assign a Library Name.

**NOTE:** All Statistics settings made with a Library Name will be directly associated with the Library name. When a Library Name is called up, the Mode and all settings will be retained with the Library Name.

Review the settings and change as necessary.

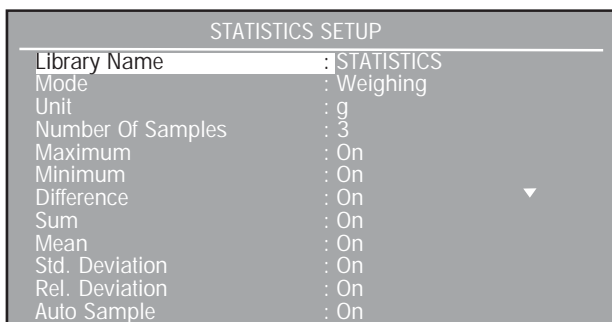

To review remaining items on the screen, scroll down.

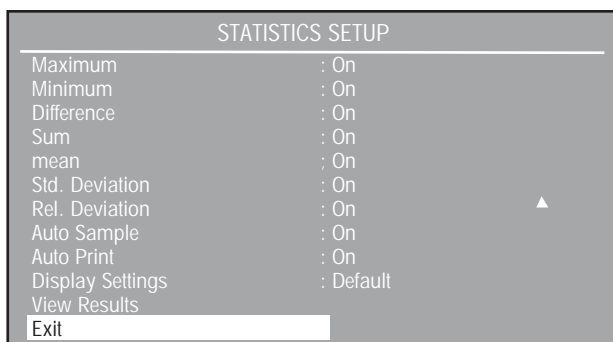

Place a container on the pan and press the **>O/T<** button to tare the container weight.

With the START key highlighted, press the **Enter** button. Follow the instructions on the screen. The START key changes to ACCEPT. Add the sample to the container. Repeat for all samples.

**Weighing/Animal Modes**

When Weighing Mode or Animal Weighing Mode is selected, The bar graph at the bottom of the screen indicates the weight of each sample when added. The Maximum, Minimum, Sum and Mean weights are also displayed on the screen.

**Filling Mode**

When the Fill Mode is selected, the Target Weight that was entered on the STATISTICS SETUP screen will display the sample weight on the bar graph as a percentage. The Maximum, Minimum, Sum, Mean and Target weights are also displayed on the screen.

**Check Weighing Mode**

When Check Weighing Mode is selected, the display at the bottom of the screen changes to Under/Accept/Over. As each sample is placed on the pan, the large numerals on the display will indicate the weight of the sample and the bar graph at the bottom of the screen indicates either Under, Accept or Over based on the Over and Under values added in the STATISTICS SETUP menu. The Maximum, Minimum, Sum, Mean Under and Over weights are also displayed on the screen.

The STATISTICAL RESULTS screen automatically appears and indicates the Number of samples, Unit, Mean, Maximum, Minimum, Standard Deviation, Relative Deviation, Sum and Difference weights. Pressing the **PRINT** button will send the screen results to an externally connected printer or computer.

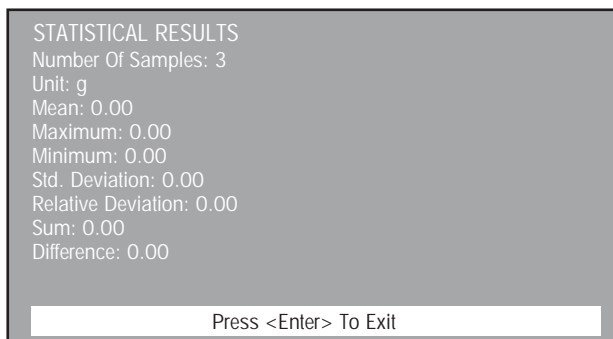

Press the **Enter** button to exit and return to the starting screen. Results may be displayed by selecting the RESULTS soft key at the top of the screen.

To start a new test, repeat the entire process.

## ADJUSTMENTS

### START/ACCEPT

When the START key is selected, pressing the **Enter** button will start statistics application. The screen displays "Add Sample #1, Press Enter" message and the Statistics process has started. When started, all the data from previous statistics is erased. At this point, the soft key has changed into an ACCEPT key. When the ACCEPT key is selected, the weight value has been accepted as valid data.

### SETUP

When selected, the STATISTICS SETUP screen will be displayed.

### RESULTS

When selected, a screen will display all calculated results.

#### Library Name:

Allows storage and recovery of parameters and results. When a library is recovered, the library name will replace the application name in the application mode screen. The library name has maximum of 18 characters.

#### Mode: Weighing, Animal, Check, Filling (default is Weighing)

Allows the selection of the various calculations in the final results.

#### Unit: g, kg, etc... (default is g)

Allows the selection of all activated units.

#### Number of Samples: xx (default is 3)

Allows manual entry for number of items. Only integer values up to 100 are valid.

#### Filter: Low, Medium, High (default is Low)-Animal mode only

Can be set to one of three filtering levels. A higher level will provide more accurate measurement.

#### Over, Under: Check mode only

Allows manual entries for the Over limit and the Under limit values. Eight decimal places are allowed for these values.

#### Target: Check mode and Filling mode

Allows manual entry for the Target Weight value. Eight decimal places are allowed for target Weight value.

#### Maximum: On, Off (default is On)

Allows Maximum to be turned On or Off. When Maximum is turned on, the maximum stored sample is included into the final results.

#### Minimum: On, Off (default is On)

Allows Minimum to be turned On or Off. When Minimum is turned on, the minimum stored sample is included into the final results.

#### Difference: On, Off (default is On)

Allows Difference to be turned On or Off. When Difference is turned on, the difference calculation between the maximum stored sample and the minimum stored sample is included into the final results.

#### Sum: On, Off (default is On)

Allows Sum to be turned On or Off. When Sum is turned on, the sum calculation of the samples is included into the final results.

#### Mean: On, Off (default is On)

Allows Mean to be turned On or Off. When Mean is turned on, the mean calculation of the samples is included into the final.



Std. Deviation: On, Off (default is On)

Allows Std. Deviation to be turned On or Off. When Std. Deviation is turned on, the standard deviation calculation of the samples is included into the final results.

Rel. Deviation: On, Off (default is On)

Allows Relative Deviation to be turned On or Off. When Relative Deviation is turned on, the relative deviation calculation of the samples is included into the final results.

Auto Sample: Off, On (default is Off)

Allows Auto Sample to be turned On or Off. When Auto Sample is turned on, the Statistics process is automatic.

Auto Print: Off, On (default is Off)

Allows Auto Print to be turned On or Off. When Auto Print is turned on, the final calculated results are automatically printed out at the end of the Statistics.

Display settings: Custom/ Default (default is Default)

Allows Display Settings to be set to default or custom. If Display Settings is set to custom, information on the result lines of the Statistics mode can be individually turned on or off. If Display Setting is set to default, all the information is turned on.

Exit:

In the sub menu, will return to the previous menu.

In the main men, will return to the last application mode.

View Results:

Allows the calculated results of the Statistics process to be viewed.

### 3.4.11 Statistical Quality Control

The Statistical Quality Control (SQC) feature is extremely useful during various types of process filling operations when it is desired to monitor and control the process to eliminate under and over filling. Provisions are made in the balance to accommodate the weight of various packaging methods. During operation, parameters of the packaged product are set into the balance such as packaging weight, acceptable weight limits and non-acceptable weight limits of the product.

These weight limits are identified as +T1, +T2, NOMINAL and -T1, -T2. As samples are weighed and stored in the balance, a trend analysis is developed and displayed on the balance. Up to 25 samples in a batch with up to ten batches are visible on a trend screen for quality control purposes. Each batch of samples is shown on the display which indicates the maximum/ minimum standard deviation and mean values for each batch. An on going examination of the relative deviation of the samples along with other statistical data can be viewed and is stored. By observing the results of the VIEW TRACE screen, you can effectively monitor the filling process operation. Setup parameters can be stored in the library and up to 5 products with statistical history can be stored in memory. All SQC information can be printed.

#### USE

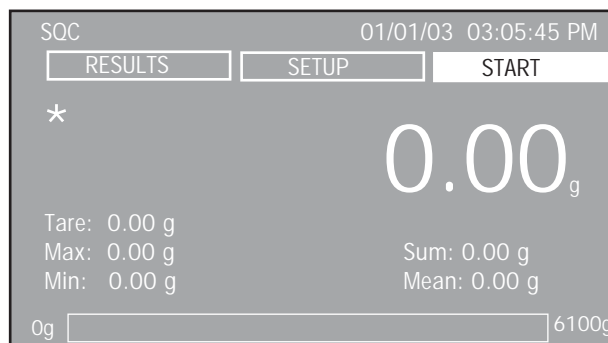

Before using the SQC feature, the SQC Setup should be reviewed. Highlight the SETUP soft key and press the **Enter** button. Assign a Library Name.

**NOTE:** All SQC settings made with a Library Name will be directly associated with the Library name. When a Library Name is called up, all settings will be retained with the Library Name.

Review the settings and change as necessary. Enter the Unit, Number of Samples, Tolerance (either weighing or percentage), Tare, Auto Sample, Auto Print, Display Settings (Default or Custom), and Batch Name.

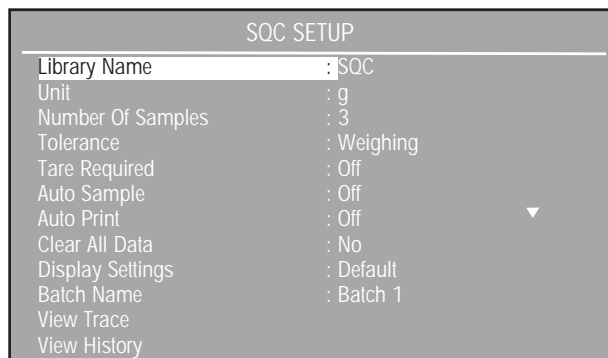

### Defining Tolerances

When Tolerance is selected a choice of either Weighing or Percent is displayed. Define either the weight or percentage for your product starting with +T2, +T1, Nominal, -T1 and -T2.

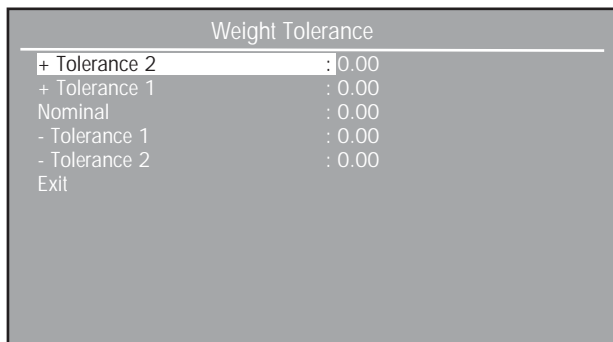

After all entries have been made, exit the SQC SETUP menu. Pressing the **Enter** button will start SQC application. Continue to place samples on the pan until all samples have been entered. The following sample screens are for 5 batches. A Nominal weight of 50.00g with T1 set at 5 g above and below and T2 set at 10g above and below. A sample history of 5 batches is displayed.

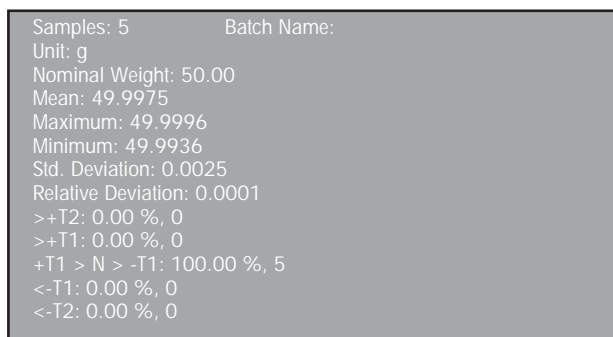

Pressing the **Enter** button will return the balance to the Start Screen. Highlight the SETUP soft key and press the **Enter** button. Assign a new Batch Name. Continue until all batches have been processed.

Return to the SETUP soft key and press the **Enter** button. Scroll down to View Trace and or View History and press the **Enter** button.

After you have taken the required number of data samples, you can view the sample View Trace and/or the View History. The View Trace screen below indicates 5 batches were processed.

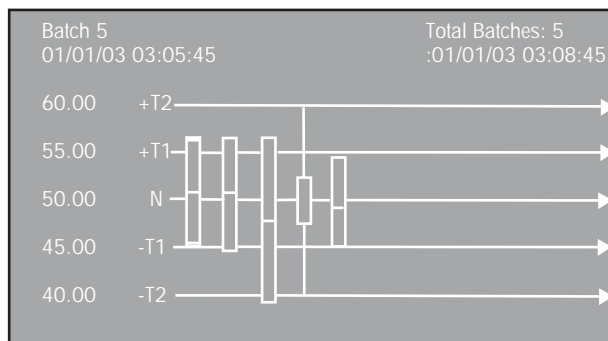

**NOTE:** Once a batch with all samples has been completed, you cannot make changes to the batch. A new batch must be run. Return to the SETUP soft key and rerun the Batch.

Definitions for the symbols are shown below.

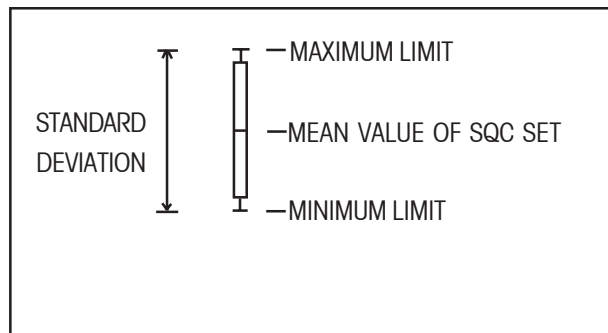

### ADJUSTMENTS

#### START/ACCEPT

When the START key is selected, pressing the **Enter** button will start SQC application. The screen displays "Add Sample #1, Press Enter" message and the SQC process has started. At this point, the soft key has changed into an ACCEPT key. When the ACCEPT key is selected, the weight value has been accepted as valid data.

#### SETUP

When selected, the SQC SETUP screen will be displayed.

#### RESULTS

When selected, a screen will display all calculated results of the SQC batch.

Library Name:

Allows storage and recovery of parameters and results.

When a library is recovered, the library name will replace the application name in the application mode screen. The library name has maximum of 18 characters.

Unit: g, kg, etc... (default is g)

Allows the selection of all activated units.

Number of Samples: xx (default is 10)

Allows manual entry for the number of samples. Only integer values up to 80 are valid.

Tolerance: Weight, Percentage (default is Weight)

Displays a screen that will allow manual editing of the tolerances. Selecting Weight or Percentage will determine the entries for tolerances which are actual weight or percentage of nominal weight.

Tare Required: Off, Mean Tare, Individual, Add w/ Mean Tare (default is Off)

Allows selection of Tare Required. When Off is selected, the balance will not prompt for a container. When Mean Tare is selected, manual entry of Mean Tare is allowed. When Individual is selected, the balance will prompt for a container weight for each sample. When Add w/ Mean Tare is selected, the entry of Mean Tare is allowed. Also, the sample weight is added and stored into the balance then the balance tares the sample weight and prompts for the next sample weight to be added and stored.

Mean Tare: Off, 00.000 (default is Off)

When Tare Required is set to Mean Tare or Add w/ Mean Tare, this menu selection will allow manual entry of the Mean Tare value.

Auto Sample: Off, On (default = Off)

Allows Auto Sample to be turned On or Off. When Auto Sample is turned on, the Statistics process is automatic.

Auto Print: Off, On (default is Off)

Allows Auto Print to be turned On or Off. When Auto Print is turned on, the final calculated results are automatically printed out at the end of the SQC process.

Clear All Data: No, Yes (default is No)

All the data from the SQC process will be erased when Yes is selected.

Display settings: Custom/ Default (default is default)

Allows Display Settings to be set to default or custom. If Display Settings is set to custom, information on the result lines of the SQC mode can be individually turned on or off. If Display Setting is set to default, all the information is turned on.

Exit:

In the sub menu, will return to the previous menu.

In the main menu, will return to the last application mode.

View Trace:

Displays a graphical representation of the last 10 batches of the SQC process to be viewed.

View History:

Displays all the calculated results for the batches of the SQC process to be viewed.

### 3.4.12 Density

Four methods of density determinations can be made with the Voyager Pro balance. These are:

1. solids more dense than water,
2. solids less dense than water,
3. liquid density,
4. porous material (impregnated with oil).

A Density Determination Kit Part Number 470007-010 is designed to be used with Ohaus Voyager Pro balances. Illustrations in this procedure refer to the density kit, however, you may use whatever lab apparatus that will suit the requirements for density measurements. A built in reference density table for water at temperatures between 10°C and 30°C is included in the balance software.

When making density measurements, the material should weigh at least 10.0 mg on an analytical balance and 100 mg on a precision balance.

**USE**

**Balance Preparation with Density Kit**

Allow the balance to warm up sufficiently before making measurements.

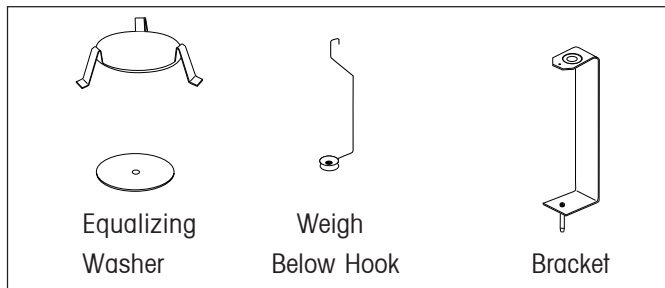

Kit Components

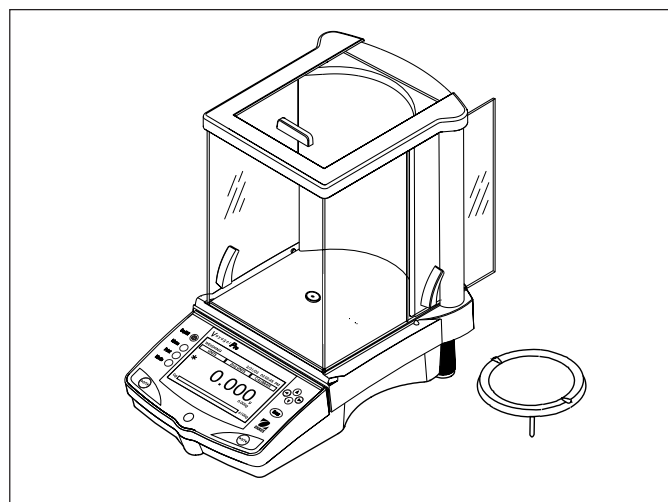

Balance Preparation

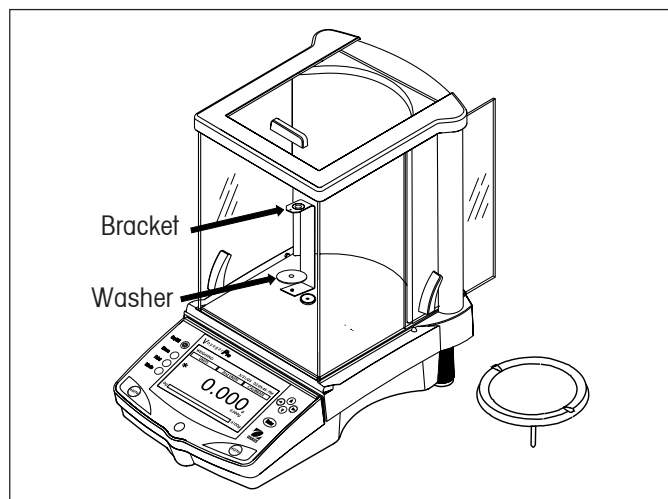

Bracket and Washer Mounting

Open either the left or right side door of the balance and remove the Pan as shown. Insert the Bracket into the balance where the Pan was removed.

On balances which are rated over 400g, place the Equalizing Washer on top of the Bracket as shown in the illustration.

Place the Support into position over the bracket making sure the Support does not make contact with the Bracket as shown in illustration.

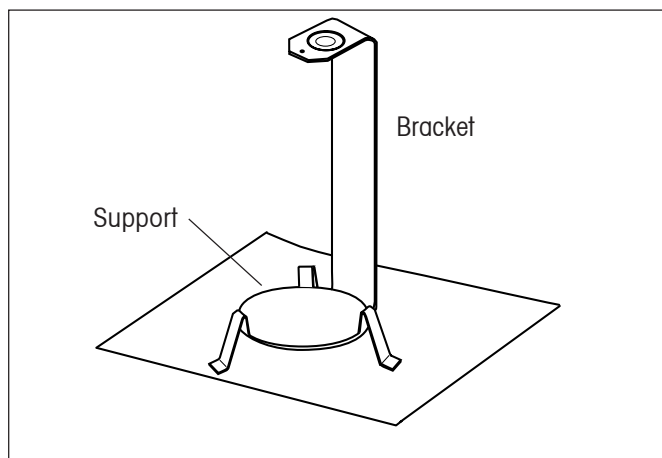

Support Mounting

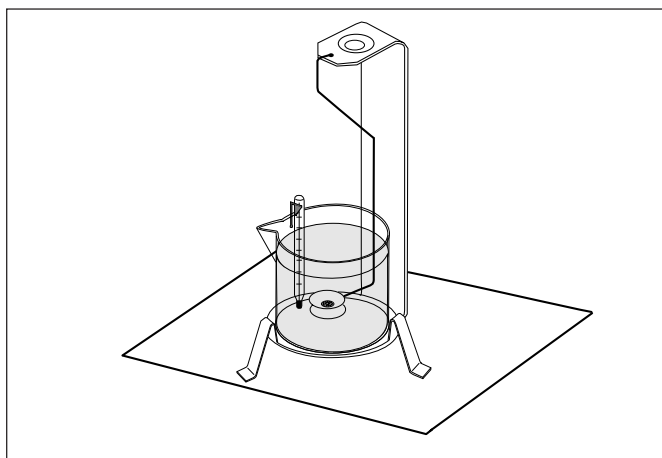

Beaker installation

Install beaker on support as shown.

**NOTE:** Beaker and thermometer are not supplied as part of the density kit.

**Solid Density Determinations for items More Dense Than Water**

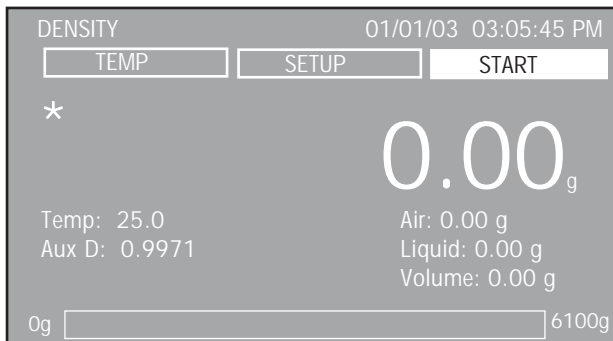

Before using the Density feature, the Density Setup should be reviewed. Highlight the SETUP soft key and press the **Enter** button. Assign a Library Name.

**NOTE:** All Density settings made with a Library Name will be directly associated with the Library name. When a Library Name is called up, all settings will be retained with the Library Name.

Review the settings and change as necessary.

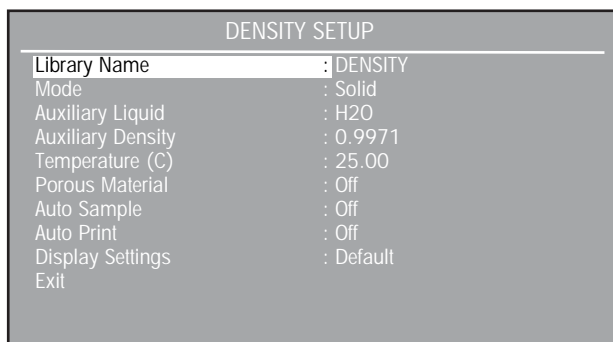

The density  $Q$  is the quotient of the mass  $m$  and the volume  $V$ .

$$Q = \frac{m}{V}$$

Density determinations are performed by using Archimedes' principle. This principle states that every solid body immersed in a fluid loses weight by an amount equal to that of the fluid it displaces. The density table for water is included in the Voyager balance software.

The density of a solid is determined with the aid of a liquid whose density,  $Q_0$ , is known (water is used as an auxiliary liquid). The solid is weighed in air ( $A$ ) and then in the auxiliary liquid ( $B$ ). The density  $Q$  can be calculated from the two weighings as follows:

$$Q = \frac{A}{A - B} \cdot Q_0$$

The balance allows direct determination of the buoyancy  $P$  ( $P = A - B$ ) and consequently the above formula can be simplified:

$$Q = \frac{A}{P} \cdot Q_0$$

- $Q$  = Density of the solid
- $A$  = Weight of the solid in air
- $B$  = Weight of the solid in the auxiliary liquid
- $Q_0$  = Density of the auxiliary liquid at a given temperature (this value depends on the temperature). The density table for water is included in Voyager balances.
- $P$  = Buoyancy of the solid in the auxiliary liquid (corresponds to  $A - B$ ).

In the event that a different liquid is to be used, provisions are made to enter the density of the desired liquid and enter its name into a library. The following procedure uses water.

Make sure a beaker with liquid is in position on the stand in the balance. Press the **>0/T<** button to zero the balance reading.

Place solid on top of the bracket as shown and close the draft shield doors. The display requests: "Place Weight In Air, Press Enter". Weigh the solid (weight *A*) and press the **Enter** button.

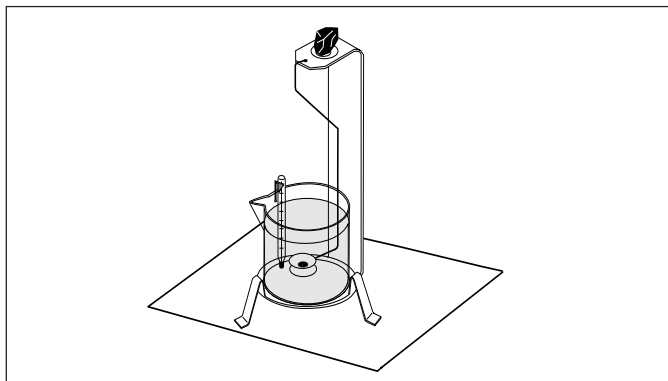

Sample Weighing in Air

The display now requests: "Place Weight In Liquid, Press Enter".

Place the solid in the Weighing Pan on the Weigh Below Hook in the liquid as shown. Ensure that there are no air bubbles on the solid to be weighed.

Close the draft shield doors and weigh the solid (buoyancy *P*) by pressing the **Enter** button. The display indicates the density in grams/cc.

Successive samples may be taken simply by pressing **Enter** with the **START** soft key highlighted. If Auto Sample was selected previously, samples can be taken as per the indication on the display.

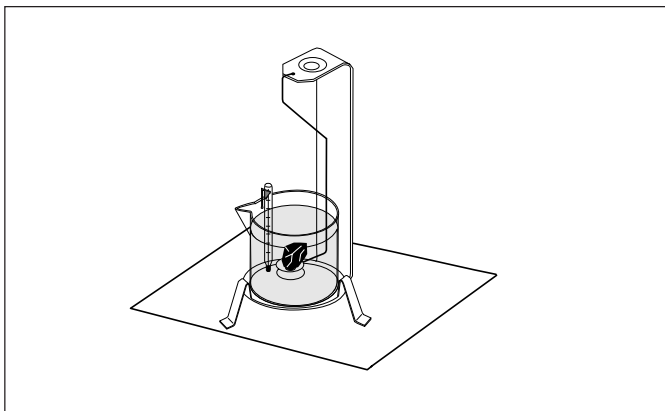

Sample Weighing in Liquid

A typical final display is shown which indicates all of the parameters and values.

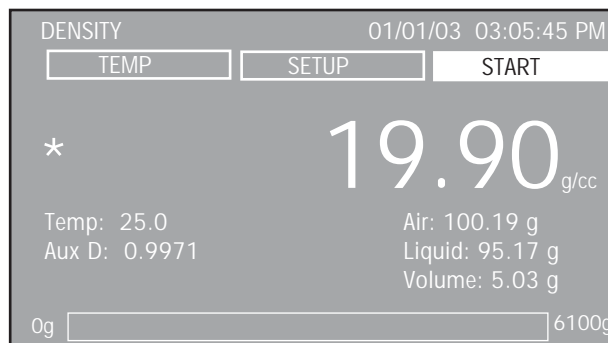

**Solid Density Determinations for items Less Dense Than Water**

For density determination of solids with a density less than 1 g/CM<sup>3</sup>, the bottom of the Weigh Below Hook for solids must be used as it holds the solid body below the surface of the auxiliary liquid. If the buoyancy of the solid is greater than the weight of the Weigh Below Hook, the Weigh Below Hook must be weighted by placing an additional mass on the submerged part of the Weigh Below Hook as shown.

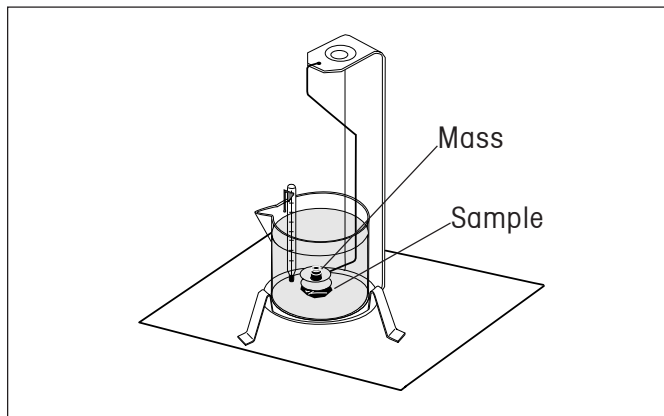

Buoyancy Sample Weighing

Weigh the sample in air first as explained in the previous procedure.

After loading the additional mass, tare the balance and start the weighing again. Wait until the balance has reached stability and note the displayed weight *P* (buoyancy of the solid).

### Improving the Accuracy of the Result of Solid Density

The following tips should help you improve the accuracy of the results in the density determination of solids.

#### Temperature

Solids are generally so insensitive to temperature fluctuations that the corresponding density changes are of no consequence. However, as work is performed with an auxiliary liquid in the density determination of solids, their temperature must be taken into account as the temperature has a greater effect with liquids and causes density changes in the order of magnitude 0.1 to 1% per °C. This effect is already apparent in the third decimal place of the result.

To obtain accurate results, we recommend that you always take the temperature of the auxiliary liquid into account on all density determinations.

#### Air Buoyancy

1 CM<sup>3</sup> of air weighs approximately 1.2 mg (depending on the physical condition). As a consequence, in the weighing in air, each solid experiences a buoyancy of this magnitude (the so-called "air buoyancy") per cm<sup>3</sup> of its volume.

However, the air buoyancy must be taken into account only when a result is required with an accuracy of 3 to 4 decimal places. To correct for this, the air buoyancy (0.0012 g per cm<sup>3</sup> volume of the body) is added to the calculated result:

$$\text{Calculated density} + 0.0012 \text{ g/cm}^3 \text{ air buoyancy} = \text{effective density}$$

#### Surface tension of the auxiliary liquid

Adhesion of the liquid to the Weigh Below Hook causes an apparent weight increase of up 3 mg.

As the Weigh Below Hook is immersed in the auxiliary liquid in both weighings of the solid (in air and in the auxiliary liquid), the influence of the apparent weight increase can be neglected because the balance is tared before every measurement.

To reduce the effect of air bubbles and to ensure the greatest possible accuracy, use a few drops of a wetting agent (not supplied) and add them to the auxiliary liquid.

### Liquid Density Determinations

The density of a liquid can be made using a sinker of known volume. The sinker is weighed in air and then in the liquid whose density is to be determined. The density,  $Q$ , can be determined from the two weighings as follows:

$$Q = \frac{A - B}{V}$$

$Q$  = Density of the liquid

$A$  = Weight of the sinker in air

$B$  = Weight of the sinker in liquid

$V$  = Volume of the sinker

$P$  = Buoyancy of the sinker in the liquid

( $P = A - B$ )

In DENSITY SETUP, set Mode to Liquid Density and enter sinker volume in cc's.

After weighing the sinker in air and then weighing the sinker immersed in liquid, the balance calculates the density of the liquid and is displayed in grams/cc. See illustrations below for placement of the sinker. When the sinker is immersed in the liquid, it **must not** come into contact with the bottom of the beaker.

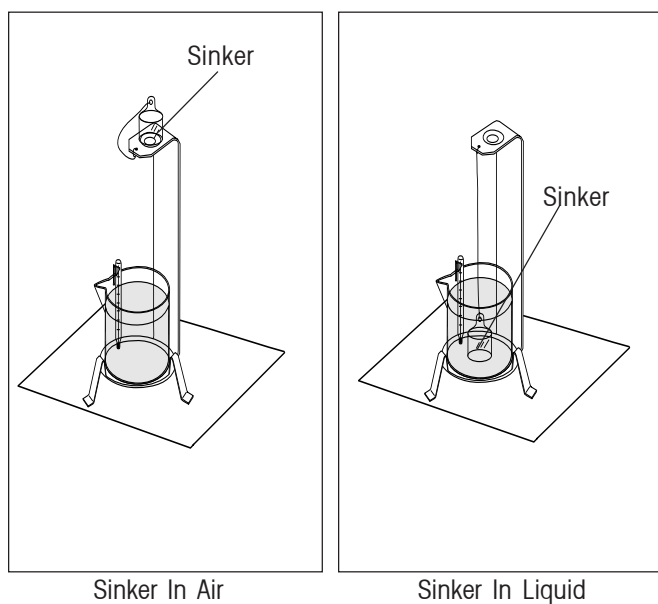

### Porous Material Density Determinations

The density of a porous (oil impregnated part) can be made with the balance. Weigh the part (dry) prior to oil impregnation and *record its weight*. You must also know the density value of the oil to be used in immersing the part before starting. In this procedure, you will follow the method for solid density measurements using water.

When Porous Material is selected and the **Enter** button is pressed, a second display POROUS MATERIAL SETUP is shown. Enter the dry weight of the porous material and the density of oil used to impregnate the part.

POROUS MATERIAL SETUP	
Dry Weight	: 0.000
Density Of Oil	: 0.000
Exit	

Exit the POROUS MATERIAL SETUP display. The DENSITY SETUP screen re-appears.

### To Determine Wet Density

Wet density of the sample can be calculated by following the normal Solid Density procedure using the oil impregnated part. When in DENSITY SETUP menu, turn off Porous Material, then follow previous solid density measuring procedure.

### ADJUSTMENTS

#### START/ACCEPT

When the START key is selected, pressing the **Enter** button will start the Density application. The screen displays "Place Weight In Air, Press Enter" message and the Density process has started. At this point, the soft key has changed into an ACCEPT key. When the ACCEPT key is selected, the weight value has been accepted as valid data.

#### SETUP

When selected, the DENSITY SETUP screen will be displayed.

#### TEMP/AUX D/SINKER

Depending on the setting, this will allow manual editing to the Temp field, the Aux. D field, or the Sinker field.

#### Library Name:

Allows storage and recovery of parameters and results. When a library is recovered, the library name will replace the application name in the application mode screen. The library name has maximum of 8 characters.

#### Mode: Solid Density, Liquid Density (default is Solid Density)

Allows selection of mass for density calculations.

#### Auxiliary Liquid: H2O, Other (default is H2O)

Allows selection of type of liquid for density calculation. If water is selected, the liquid density is fixed to 0.9971 g/cc and the temperature of the water can be manually entered. If other is selected, the density of the liquid can be manually entered.

#### Auxiliary Density: 00.000

When Auxiliary Liquid is set to water, Auxiliary Density is fixed to 0.9971 g/cc. When Auxiliary Liquid is set to other, the density of liquid can be manually entered.

#### Temperature: 00.00

When Auxiliary Liquid is set to water, the temperature of the water can be manually entered.



Porous Material: Off, On (default is Off)

Allows Porous Material to be turned On or Off . When Porous Material is turned on, a screen is displayed to allow the manual entry of Dry Weight and Density Of Oil.

Sinker Volume: 000.00

Allows the volume of the sinker to be manually entered.

Auto Sample: Off, On (default is Off)

Allows Auto Sample to be turned On or off . When Auto Sample is turned on, the Density process is automatic.

Auto Print: Off, On (default is Off)

Allows Auto Print to be turned On or off . When Auto Print is turned on, the final calculated results are automatically printed out at the end of the Density process.

Display settings: Custom/ Default (default is Default)

Allows Display Settings to be set to default or custom. If Display Settings is set to custom, information on the result lines of the Density mode can be individually turned on or off. If Display Setting is set to default, all the information is turned on.

Exit:

In the sub menu, will return to the previous menu.

In the main menu, will return to the last application mode.

### 3.4.13 Pipette Calibration

Pipette calibration checks the accuracy and precision values of pipettes by weight analysis. An analytical balance is recommended for maximum accuracy. The balance is capable of recording data from 3 to 30 samples of each pipette tested. Each test run is stored in the application library. The number of tests which can be stored will depend on the number of samples per test. The density table for water is included. If other liquids are used for pipette calibration, you must enter the liquid's density in g/cc at current room temperature. Since all calculations are made within the balance, it is also required that you know the atmospheric pressure which has to be entered. A printout can be made which specifies all parameters of the test made.

## USE

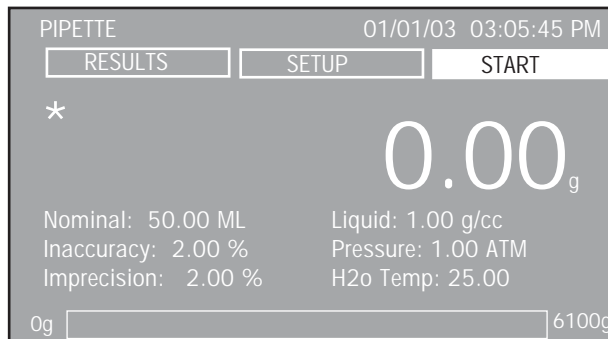

Review the settings and change as necessary.

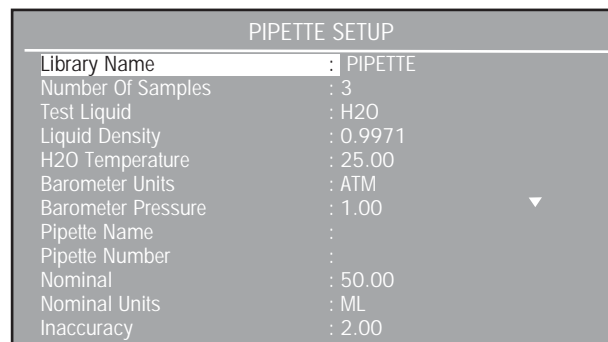

To review remaining items on the screen, scroll down.

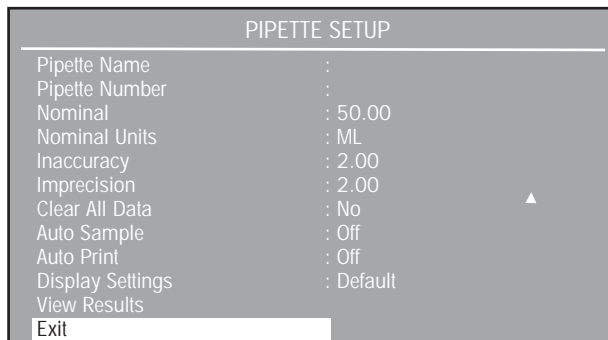

Place a container on the pan and press the >0/T< button to tare the container weight. When Auto Sample has been selected, each sample can be made automatically without touching the balance. The screen will display messages to add samples.

When testing microliter pipettes, add the samples in rapid succession to avoid evaporation errors in the liquid. An Analytical balance should be used for microliter pipette testing

With the START key highlighted, press the **Enter** button. Follow the instructions on the screen. The START key changes to ACCEPT. Add the sample to the container. Repeat for all samples.

**NOTE:** When Auto Sample has been selected, it is not necessary to press the **Enter** button for each sample. If the balance fails to advance to the next sample, press the **Enter** button.

Place the first sample from the pipette into the vessel and press **Enter**. The display indicates Add Sample # 1, place the second sample from the pipette into the vessel and press **Enter**.

Repeat the above steps until all samples have been run. When the last sample is placed on the balance and the **Enter** button is pressed, the panel display indicates the results of the test which includes the Date, Time, Status, Nominal value, Inaccuracy and Imprecision.

The graph on the display indicates the mean value in the center with standard deviation and 2 times standard deviation above and below shown as lines across the screen. Each sample is shown as a diamond shaped mark on the graph. A ten sample set is shown.

If Auto Print was selected during the setup, the results are automatically printed. Printout contains numerical results and all statistics.

For manual printing of test results, press the **Print** button on the balance.

### ADJUSTMENTS

#### START/ACCEPT

When the START key is selected, pressing the **Enter** button will start statistics application. The screen displays "Add Sample #1, Press Enter" message and the Pipette process has started. At this point, the soft key has changed into an ACCEPT key. When the ACCEPT key is selected, the weight value has been accepted as valid data.

#### SETUP

When selected, the PIPETTE SETUP screen will be displayed.

#### RESULTS

When selected, a screen will display all calculated results.

#### Library Name:

Allows storage and recovery of parameters and results. When a library is recovered, the library name will replace the application name in the application mode screen. The library name has maximum of 18 characters.

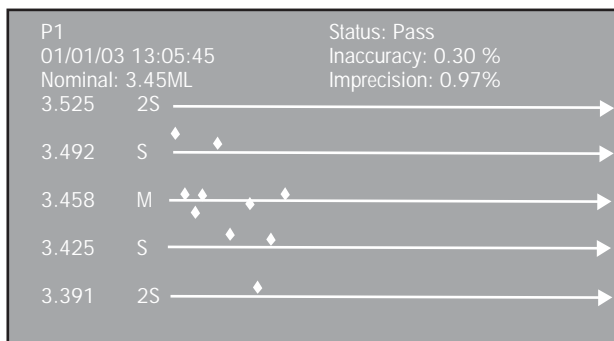

Number of Samples: xx (default is 10)

Allows manual entry for the number of samples. Only integer values up to 30 are valid.

Test Liquid: H2O, Other (default is H2O)

Allows selection of test liquid. When water is selected, the temperature of the water can be manually entered. When other is selected, the density of the liquid can be manually entered.

Liquid Density: 000.00

Allows manual entry of the density of the liquid. If water is selected for Test Liquid, then the liquid density is fixed to 0.9971 g/cc.

H2O Temperature: 00.000

Allows manual entry of the temperature of water.

Barometer Unit: ATM, PSIA (default is ATM)

Allows the selection of barometer units.

Baro. Pressure: 00.00

Allows the barometer pressure to be manually entered.

Pipette Name: xxxxxx

Allows manual entry for assigning a pipette name. 8 characters max.

Pipette Number: xxxxx

Allows manual entry for assigning pipette number. 8 characters max.

Nominal: 000.00

Allows the nominal value to be manually entered.

Inaccuracy: 000.00

Allows the inaccuracy value to be manually entered.

Imprecision: 000.00

Allows the imprecision value to be manually entered.

Clear All Data: No, Yes (default is No)

All the data from the Pipette process will be erased when Yes is selected.

Auto Sample: Off, On (default is Off)

Allows Auto Sample to be turned On or Off. When Auto Sample is turned on, the Pipette process is automatic.

Auto Print: Off, On (default is Off)

Allows Auto Print to be turned On or off. When Auto Print is turned on, the final calculated results are automatically printed out at the end of the Pipette process.

Display settings: Custom/ Default (default is Default)

Allows Display Settings to be set to default or custom. If Display Settings is set to custom, information on the result lines of the Density mode can be individually turned on or off. If Display Setting is set to default, all the information is turned on.

Exit:

In the sub menu, will return to the previous menu.

In the main menu, will return to the last application mode.

View Results:

Displays the calculated results of the Pipette process to be viewed.

### 3.5 Balance Settings

The Voyager Pro balance contains eleven submenus that are accessible from the Main Menu. The submenus are Calibration, Balance Options, Readout, Application Modes, Units, Interface, Print Options, GLP Print Options, Library, Lockout and Factory Reset.

Each of the submenus contain settings that will affect the operation of the balance. Please review all submenus settings to obtain the best performance from the balance. Make the necessary settings to suit specific needs.

#### 3.5.1 Calibration

Press the Menu button and select CALIBRATION. Press the **Enter** button, the CALIBRATION screen is displayed. Voyager Pro balances offers a choice of five calibration methods: Internal Calibration, Autocal Calibration, Span Calibration, Linearity Calibration and User Calibration,

Linearity, Span and User calibration are disabled for Type Approved/LFT balances Class II and Class III.

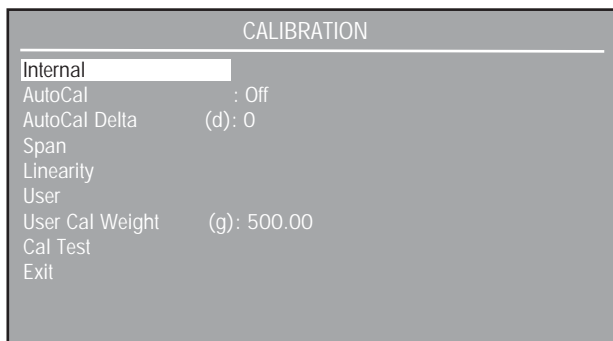

**IMPORTANT !  
DO NOT DISTURB THE BALANCE  
DURING CALIBRATION.**

##### Internal Calibration

Calibration is accomplished using the internal calibration mass. Internal calibration can be performed at any time providing the balance has warmed up to operating temperature and is level.

AutoCal: On, Off (default is On)

When AutoCal is set ON, the balance performs a self calibration when a measured predefined delta temperature change occurs. After calibration, the display returns to the last application mode. Environmental conditions must be met for the AutoCal to be successfully completed.

AutoCal Delta: -100 - +100 (default is 0)

AutoCal Delta allows the internal calibration mass value to be adjusted. This permits calibrating the balance using an external mass which is traceable to a certified standard.

Perform the internal calibration procedure. After the calibration is completed, zero the balance.

Place a certified mass equal to the **span calibration value** of the balance.

Compare the reading on the balance to the expected weight being used. If the reading is above the expected weight, the delta entered in digits is negative. If the reading is below the expected weight, the delta entered in digits is positive.

See following example:

Actual Weight Reading:	200.0014
Expected Weight Reading:	200.0000
Delta Weight (d):	0.0014
Delta weight in Digits:	-14

Recalibrate using internal calibration. After calibration, place the certified mass on the pan and see if the mass agrees with the displayed value. If not, repeat procedure until internal calibration reading agrees with the certified mass.

##### Span Calibration:

Span calibration utilizes two calibration points, one at zero load and the other at specified full span. See the following table.

**CALIBRATION MASSES**

<b>CAPACITY</b>	<b>LINEARITY MASSES</b>	<b>SPAN ONLY MASSES</b>
62 g	20g/50 g	50 g
162 g	50g/150 g	150 g
110 g	50g/100 g	100 g
210 g	100g/200 g	200 g
410 g	200g/400 g	400 g
510g/610 g	200g/500 g	500 g
1550 g	500g/1500 g	1500 g
2100 g	1000g/2000 g	2000 g
4100 g	2000g/4000 g	4000 g
6100 g	2000g/5000 g	5000 g
8100 g	4000g/8000 g	8000 g

If it is recommended that masses must meet or exceed ASTM Class 1 Tolerance. Calibration masses are available as accessories.

Additional calibration values to be used are shown on the display screen. The best accuracy is achieved using the mass closest to the full span value. After calibration, the display returns to the last application mode.

Linearity Calibration:

Linearity calibration utilizes three calibration points, one at zero load and two at specified calibration masses. This method minimizes deviation between actual and displayed weights within the balance's weighing range. After calibration, the display returns to the last application mode.

User Calibration:

User calibration is used when it is desired to calibrate the balance using a user defined mass. The user defined mass value has to be entered in the User Cal Weight. After calibration, the display returns to the last application mode.

User Calibration Weight: 25%-100% of capacity (default is Span)

Defines the mass value for User calibration. The user calibration may now be done with the mass selected.

Cal Test:

Calibration test feature allows a check of a known calibration mass against the last stored calibration information in the balance.

The display indicates the difference in weight between calibration mass placed on the pan and the previous weight value which was stored in the balance. After Cal Test, the display returns to the last application mode.

**3.5.2 Balance Options**

Press the **Menu** button, and select Balance Options.

Press the **Enter** button. The BALANCE OPTIONS screen is displayed.

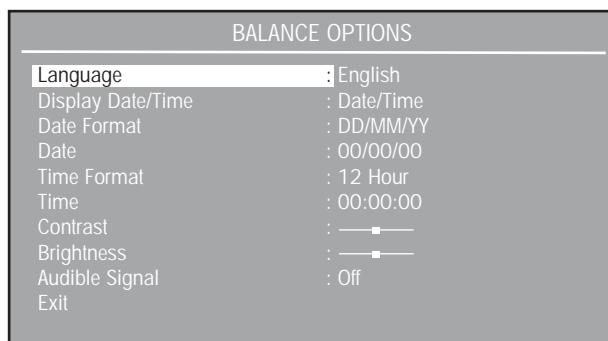

Languages: English, Spanish, etc...(default is English)

Allows the selection of English, Spanish, French, German or Italian as the operating language to be displayed.

Display Date/Time: Time, date, etc...(default is Date/Time)

Allows display selection of Time, Date, Date/Time or Off in the upper right-hand corner of the Application Mode screen.

Date Format: MM/DD/YY, YY/MM/DD, ETC...(default is MM/DD/YY)

Allows setting of one of six date formats: MM/DD/YY, YY/MM/DD, DD/MM/YY, DD/YY/MM, MM/YY/DD or YY/DD/MM.

Date: 00/00/00 (default is none)

Allows setting the present date.

Time Format: 12 Hour, 24 hour(default is 12 Hour)

Allows setting the time format of either 12 hours or 24 hours.

Time: 00:00:00 (default is none)

Allows setting the present time of hours, minutes and AM/PM. Valid numbers change with time format from 1->12 to 0->23. When in 24 hour mode, no AM/PM flag appears.

Contrast:

Allows adjusting the contrast level of the display.

Brightness:

Allows adjusting the brightness level of the display.

Audible Signal: On, Off (default is Off)

With audible signal set On, each button press will generate a tone.

Exit:

When selected, returns to previous screen.

### 3.5.3 Readout

Press the **Menu** button, and select Readout.

Press the **Enter** button. The READOUT screen is displayed.

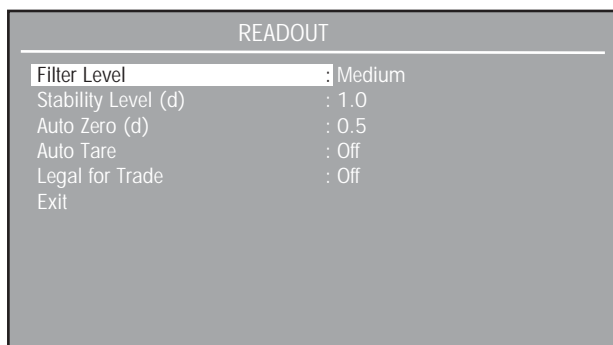

Filter Level: Low, Medium, High (default is Medium)

Sets the balance reading averaging level to a value of Low, Medium or High. A higher filter level will provide a more repeatable measurement.

Stability Level: 0.5, 1.0, etc... (default is 1.0)

Sets the balance stability level for the stability indicator to either 0.5, 1.0, 2.0 or 5.0. A 0.5 setting is equivalent to end result of .5 display digit. A 5.0 setting is equivalent to end result of 5 display digits.

Auto Zero: Off, 0.5, etc... (default is 0.5)

Sets the balance auto zero level to either Off, 0.5, 1.0, 2.0 or 5.0. Auto Zero tracking compensates for the drift at zero load. 0.5d means 0.5 display digit drift compensation per second. 5.0d means 5 display digit drift compensation per second.

Auto Tare: On, Off (default is Off)

Sets the Auto Tare function to On or Off. This feature provides auto tare in all application modes. When Auto Tare is On, the balance waits for the container/load to be placed on the pan and automatically tares it. This function is repeated for each new container/load.

Legal for Trade: On, Off (default is Off)

Sets the Legal for Trade (LFT) function either On or Off. Refer to paragraph paragraph 3.5.12 for additional information.

### 3.5.4 Application Modes

Press the **Menu** button, and select Application Modes.

Press the **Enter** button APPLICATION MODES screen is displayed.

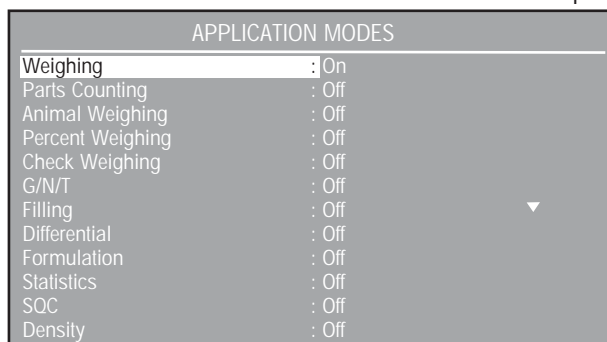

All application modes are displayed on this screen. Each mode may be set on or off. These modes are cycled through when the **Mode** button is pressed.

### 3.5.5 Units

Press the **Menu** button, and select Units. The UNITS screen displays a list of the available weighing units. Depending on the model, some units are not available.

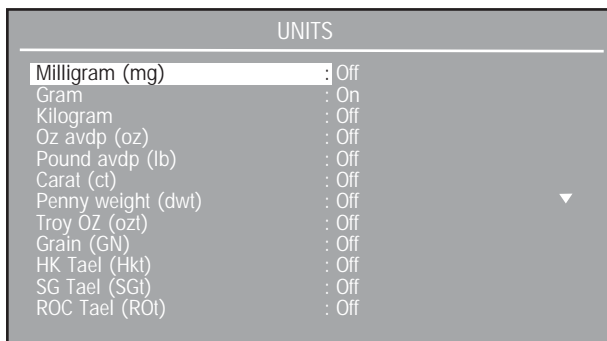

Scroll down using arrow button to view remaining units.

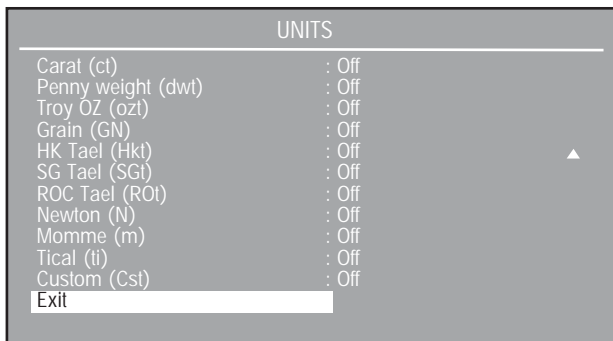

Milligram (mg): On, Off (default is Off)  
 Unit (mg) = g x 1000, displayed readability by 1.

Gram (mg): On, Off (default is On)  
 Unit (g) = g x 1, displayed readability by 1.

Kilogram (kg): On, Off (default is Off)  
 Unit (kg) = g x .001, displayed readability by 1.

OZ avdp (oz): On, Off (default is Off)  
 Unit Ounces (oz) = g x .03527396, displayed readability by 5.

Pound avdp (lb): On, Off (default is Off)  
 Unit Pounds (lb) = g x .002204623, displayed readability by 5.

Carats (ct): On, Off (default is Off)  
 Unit (ct) = g x 5, displayed readability by 5.

Pennyweight (dwt): On, Off (default is Off)  
 Unit (dwt) = g x .6430149, displayed readability by 1.

Troy OZ (ozt): On, Off (default is Off)  
 Unit (ozt) = g x .03215075, displayed readability by 5.

Grain (GN): On, Off (default is Off)  
 Unit (GN) = g x 15.43236, displayed readability by 2.

Hong Kong Tael (Hkt): On, Off (default is Off)  
 Unit (Hkt) = g x 0.02671725, displayed readability by 5.

Singapore Tael (SGt): On, Off (default is Off)  
 Unit (SGt) = g x 0.02645547, displayed readability by 5.

ROC Tael (ROt): On, Off (default is Off)  
 Unit (ROt) = g x 0.02666667, displayed readability by 5.

Newton (N): On, Off (default is Off)  
 Unit (N) = g x 0.00980665, displayed readability by 1.

MOMME (m): On, Off (default is Off)  
 Unit (m) = g x 0.2666667, displayed readability by 5.

Tical (ti): On, Off (default is Off)  
 Unit (ti) = g x 0.0612395, displayed readability by 1.

Custom Unit (Cst): On, Off (default is Off)  
 When the Custom Unit is set On, the CUSTOM UNIT screen will appear.

This feature can be used to create a custom weighing unit. It permits entering a conversion factor which the balance will use to convert grams to the desired unit of measure.

$$\text{Conversion Factor} \times \text{Grams} = \text{Custom Unit}$$

Unit (Cst) = g x user set custom factor, displayed resolution can not exceed resolution in gram.

Conversion factors are expressed in scientific notation and entered into the balance in three parts:

- Mantissa (0.1 and 1.999999)
- Exponent (10<sup>E</sup>)
- Least Significant Digit (LSD)

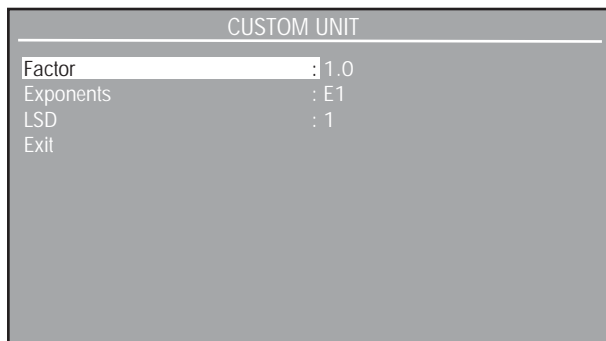

SCIENTIFIC NOTATION				
Conv. Factor	Mantissa Between 0.1 and 1.999999	Exponent	Man-tissa	Exp. (10 <sup>E</sup> )
123.4	= .1234	x 1000	= .1234	x 10 <sup>3</sup>
12.34	= .1234	x 100	= .1234	x 10 <sup>2</sup>
1.234	= .1234	x 10	= .1234	x 10 <sup>1</sup>
.1234	= .1234	x 1	= .1234	x 10 <sup>0</sup>
.01234	= .1234	x .1	= .1234	x 10 <sup>-1</sup>
.001234	= .1234	x .01	= .1234	x 10 <sup>-2</sup>
.000123	= .123	x .001	= .123	x 10 <sup>-3</sup>

EXPONENTS	
E-3	Moves decimal point 3 places to the left.
E-2	Moves decimal point 2 places to the left.
E-1	Moves decimal point 1 place to the left.
<b>E 0</b>	<b>Leaves decimal point in normal position.</b>
E1	Moves decimal point 1 place to the right.
E2	Moves decimal point 2 places to the right.
E3	Moves decimal point 3 places to the right.

LSD's	
LSD .5	Adds one decimal place display counts by 5's.
<b>LSD 1</b>	<b>Display counts by 1's.</b>
LSD 2	Display counts by 2's.
LSD 5	Display counts by 5's.
LSD 10	Display counts by 10's.
LSD 100	Display counts by 100's.

### 3.5.6 Interface

Press the **Menu** button, and select Interface.

Press the **Enter** button, The INTERFACE screen is displayed.

INTERFACE	
Baud Rate	: 2400
Parity	: None
Data Bits	: 7
Stop Bits	: 2
Exit	

Baud Rate: 300, 1200, etc...(default is 2400)  
Baud Rate is selectable between 300, 1200, 2400, 4800 or 9600 BPS.

Parity Bit: None, Odd, Even (default is None)  
Parity Bit is selectable between None, Odd or Even.

Data Bits: 7, 8 (default is 7)  
Data Bits is selectable between 7 or 8 data bits.

Stop Bits: 1, 2 (default is 2)  
Stop Bits is selectable between 1 or 2 stop bits.

Exit:  
Will return to previous display.

### 3.5.7 Print Options

Press the **Menu** button, and select Print Options.

Press the **Enter** button PRINT OPTIONS screen is displayed.

PRINT OPTIONS	
Auto Print	: Off
Print Interval	: Off
Stable Data	: Off
Numeric Data	: Off
Exit	

Auto Print: Off, interval, etc... (default is Off)

When enabled, the Auto Print feature causes the balance to automatically output display data in one of three ways: continuously, at user specified time intervals, or upon stability.

- OFF            Turns off the auto print feature.
- Interval      Provides a user specified printing interval
- Stable        Provides printed data each time a stable reading is achieved.
- Continuous   Outputs data continuously.

Print Interval: 1-3600 (default is 1)

When Auto Print is set to Interval, a specified printing interval between 1 and 3600 seconds can be set.

Stable Data: Load, Load & Zero (default is Load)

When Auto Print is set to Stable, an option of Load or Load & Zero can be set.

- Load            Will print stable load data only.
- Load & Zero    Will print stable load data and stable zero data.

Numeric Data: On, Off (default is Off)  
When set On, will print numeric data.

### 3.5.8 GLP Print Options

GLP stands for Good Laboratory Practice. The GLP Print Options enables the printing of a Date & Time, Balance ID, Project Name, User Name, Calibration, Reference, Application Mode and Result lines. Press the Menu button, and select GLP Print Options.

Press the Enter button GLP PRINT OPTIONS screen is displayed.



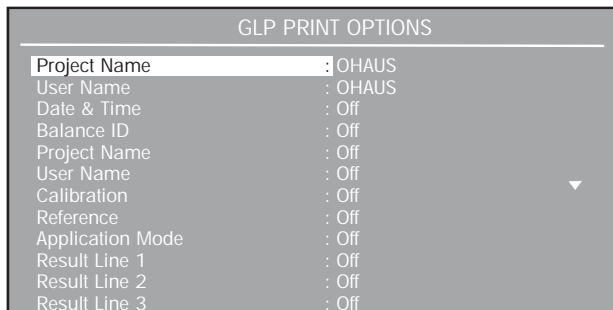

Project Name: (default is OHAUS)  
A project name of up to 8 characters may be entered.

User Name: (default is OHAUS)  
A user name of up to 8 characters may be entered.

Date & Time: On, Off (default is Off)  
When set On, will output date and time.

Balance ID: On, Off (default is Off)  
When set On, will output Balance ID.

Project Name: On, Off (default is Off)  
When set On, will output project name.

User Name: On, Off (default is Off)  
When set On, will output User name.

Calibration: On, Off (default is Off)  
When set On, prints out the calibration data after the completion of every calibration process. See sample of span calibration.

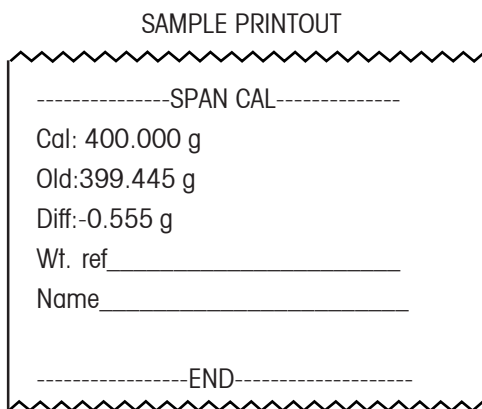

Reference: On, Off (default is Off)  
When the Reference function is set ON, it will output the value of weight used as a reference in either Percent Weighing mode or Parts Counting mode.

Application Mode: On, Off (Default is Off)  
When set to On, the Application name will be printed during a print operation.

Result Lines: On, Off (Default is Off)  
Each of the six Result Lines can be set independently. When set to On, the Result Line information will be printed

Exit:  
When selected, returns to previous menu.

### 3.5.9 Library

Ten functions in the balance have provisions for storing a library name, they are: Parts Counting, Check Weighing, Differential Weighing, Formulation, Statistics, Statistical Quality Control (SQC), Density, Pipette, When a library name is selected, the associated function is also displayed. A Library menu is provided which allows the selected library name and function to be run, deleted or delete all entries. If you have accessed the library and do not want to run or delete a name, an exit to weighing selection can be made by pressing the **Menu** button which does not affect the library

Select LIBRARY function and press the **Enter** button. Display advances to LIBRARY menu with RUN, DELETE and DELETE ALL options shown.

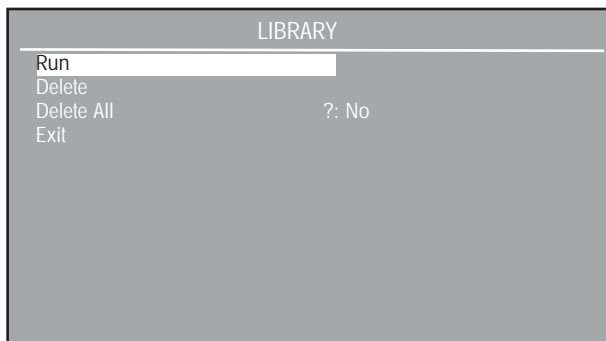

Select either RUN, DELETE, or DELETE ALL. When RUN is selected, a screen showing all stored libraries is displayed. Any stored library can be recalled, enabled and run. All parameters from a previously run library are retained.

When a particular name is selected and the DELETE selection is made, that particular name and function with all parameters is removed from the library.

DELETE ALL, when selected, removes the entire contents of the library.

### 3.5.10 Lockout

Provides the capability to lock the Menu settings individually to protect selected parameters against modifications. Locked means the items can be viewed but not changed.

Press the **Menu** button, and select Lockout.

Press the **Enter** button LOCKOUT screen is displayed.

LOCKOUT	
Calibration	: Unlocked
Balance Options	: Unlocked
Readout	: Unlocked
Application Setup	: Unlocked
Application Modes	: Unlocked
Units	: Unlocked
Interface	: Unlocked
Print Options	: Unlocked
GLP Print Options	: Unlocked
Factory Reset	: Unlocked
Exit	

The default setting for all items on the LOCKOUT screen are Unlocked.

### 3.5.11 Factory Reset

The FACTORY RESET allows parameters to be set to the default values. Each menu item can be reset by setting to Yes. After accepting the changes, the balance will reset the selected menus items. Global Reset will change all menus to a factory setting in one step.

Press the **Menu** button, and select Factory Reset.

Press the **Enter** button FACTORY RESET screen is displayed.

FACTORY RESET	
Calibration	: No
Balance Options	: No
Readout	: No
Application Modes	: No
Units	: No
Interface	: No
Print Options	: No
GLP Print Options	: No
Lockout	: No
Global Reset	: No
Accept Changes	: No

The balance default parameters are listed as follows:

#### Calibration:

Auto Cal: On

Autocal delta: 0

User Cal weight = Span weight

#### Balance Options:

Language: English

Display Date/Time: Date/Time

Date Format: MM/DD/YY

Time Format: 12 Hour

#### Readout:

Filter Level: Medium

Stability Level (d): 1.0

Auto Zero (d): 0.5

Auto Tare: Off

Legal for Trade: Off

#### Application Modes:

Weighing: On

All others Off

#### Units:

Grams On, all others Off.

#### Interface:

Baud Rate: 2400

Parity: None

Data Bits: 7

Stop Bits: 2

#### Print Options:

Auto Print: Off

Print Interval: Off

Stable Data: Off

Numeric Data: Off

#### GLP Print Options:

Balance ID=OHAUS

User Name = OHAUS

All others Off

#### Lockout:

All Unlocked

### 3.5.12 LFT Legal for Trade

Legal for Trade (LFT) is a software controlled option which can be set ON in the Readout menu. When LFT is set ON, certain items in the Calibration, Readout and Print menus are automatically preset and locked to permit the balance to operate in a legal for trade application and works in conjunction with a Lockswitch. Default setting is OFF. See default table.

**LFT DEFAULT TABLE**

LFT and Lockswitch	Default Value
<b>Balance Menu</b>	
<b>Readout</b>	
Stability Level	<b>Locked to 1</b>
Auto Zero	<b>Limited to OFF &amp; 0.5</b>
<b>Auto Cal</b>	
Print Current Settings	<b>Locked to ON</b>
	Balance will only output stable data.

When the balance is first turned ON and LFT has been previously set ON, the initial display will indicate that LFT is ON. The last digit on the weighing display will be highlighted in white and is used to indicate the auxiliary digit.

Depending upon country regulations, additional settings will have to be locked. Before sealing the balance, check with your local Weights and Measure official.

### 3.5.13 Hardware Lockswitch

Access to the various menus can be disabled setting the Lockswitch located on the PC board inside the balance to locked position. The Lockswitch locks out all menus which have been set to LOCKED. The default setting for the Lockswitch is UNLOCKED.

### 3.5.14 Sealing the Balance

Certified balances have a securing sticker and additional labeling applied at the factory. When subsequent verification is carried out, they can be sealed either with a lead seal and wire, or with a new securing sticker.

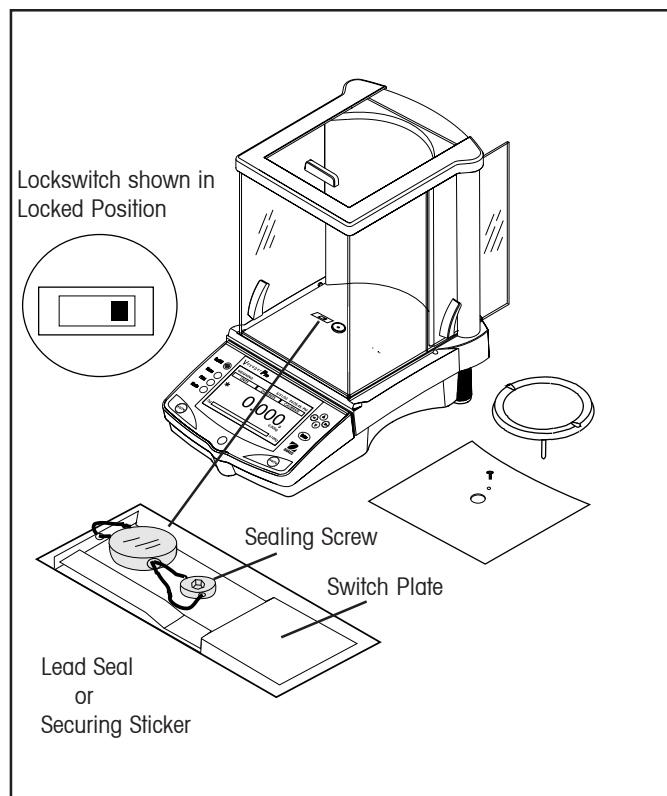

Example of Sealing Method

## 3.6 Printing Data

Printing data requires that the Interface menu, Print Options and GLP Print Options are set properly.

Pressing the **Print** button will initiate printing each time it is pressed.

Sample printout is shown below with GLP Options turned on.

SAMPLE PRINTOUT

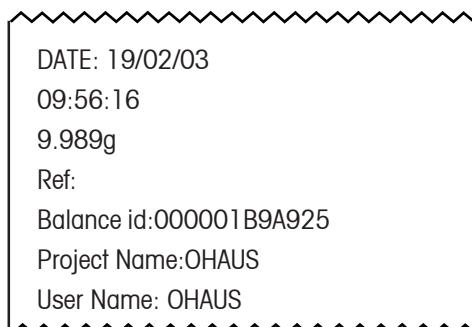

## 4. CARE AND MAINTENANCE

### 4.1 Cleaning

To keep the balance operating properly, the housing and pan should be kept clean and free from foreign material. If necessary, a cloth dampened with a mild detergent may be used. Keep calibration masses in a safe dry place.

### 4.2 Troubleshooting

SYMPTOM	PROBABLE CAUSE(S)	REMEDY
Unit will not turn on.	Power cord not plugged in or properly connected to balance.	Check power cord connections.
Incorrect weight reading.	Balance was not tared before weighing. Balance out of level. Balance not properly calibrated.	Press >O/T< with no weight on the pan, then weigh item. Adjust leveling feet. Recalibrate correctly.
Cannot display weight in desired unit.	Desired unit not enabled.	Enable units in Units menu.
Cannot access desired application.	Desired application mode is not enabled.	Enable desired application in Application Modes menu.
Unable to change menu settings.	Menu locked.	Verify that Lockswitch is in the Off position, unlock menu in the Lockout menu.
RS232 interface not working.	Interface parameters not properly set up. Incorrect cable being used. Cable connections.	Verify interface settings in RS232 menu correspond to those of peripheral device. Refer to Accessory list for proper cable. Check cable connections are installed properly. Check correct cable end is plugged into the balance.
Unstable readings.	Vibration on table surface.	Check environmental conditions. Close draft shield doors. Change averaging level to a higher setting or place balance on a stable surface
Error message display.	_____	See Error Codes list.
Incorrect calibration	Balance not tared. Internal calibration not adjusted properly.	Tare the balance. Perform calibration adjustments.

## 4.3 Error Codes List

### Error Codes List

The following list describes the various error codes that can appear on the display and the suggested remedy.

#### Data Errors

- 1.0 Transient error (hardware error, probably static discharge). If error persists, the balance must be serviced.
- 1.1 Balance temperature transducer hardware error.
- 1.2 No data from main board.

#### Tare Errors

- 2.0 Balance is unable to stabilize within time limit after taring. Environment is too hostile or balance needs recalibration.

#### Calibration Errors

- 3.0 Incorrect or no calibration mass used for calibration. Recalibrate with correct masses.

#### RS232 Errors

- 4.4 RS232 buffer is full.

#### User Errors

- 7.0 User entry out of bounds.
- 7.2 Number outside of display capacity.

#### Over-Under Load Errors

- 8.0 Hardware error causing an internal weight signal which is too low. Check if pan is off. If not, the balance must be serviced.
- 8.1 Hardware error caused by an internal weight signal which is too high. Check load on the pan which may be excessive. If error persists, the balance must be serviced.
- 8.2 Power-on load out of specification (LFT only)
- 8.3 Rated capacity exceeded. Remove excessive weight from pan.
- 8.4 Underload condition on balance. Check that the proper pan is installed.
- 8.5 Auto Cal weight internal sensor indicated its weight on the pan.

#### Checksum Errors

- 9.1 Bad factory checksum. If error persists, have the balance serviced.
- 9.2 Bad factory checksum. If error persists, have the balance serviced.
- 9.3 Bad factory checksum. If error persists, have the balance serviced.
- 9.4 Auto Cal data failed checksum. This failure will disable access to the Auto Cal feature (if installed).
- 9.5 Factory calibration data failed checksum.
- 9.6 Bad program checksum.
- 9.7 Bad CMOS checksum.
- 9.8 User calibration data failed checksum.
- 9.9 Factory temperature compensation data failed checksum.

## 4.4 Service Information

If the Troubleshooting section does not resolve or describe your problem, you will need to contact an authorized Ohaus Service Agent. For Service assistance in the United States, please call Aftermarket, Ohaus Corporation toll-free at (800) 526-0659. An Ohaus Product Service Specialist will be available to help you. Global contact addresses and phone numbers are accessible on [www.ohaus.com](http://www.ohaus.com).

## 4.5 Replacement Parts

<u>Description</u>	<u>U.S. Part No.</u>	<u>Global Part No.</u>
Power Pack, 100/120 V ac US Plug (Cord set part of power pack)	490202-010	21202536
Power Pack, (Cord set required for UK, European and Australian)	490203-010	21202537
Cord Set, 230 V ac, UK Plug	76448-00	89405
Cord Set, 230 V ac, European Plug	76212-00	87925
Cord Set, 230 V ac, Australian plug	76199-01	88751
In-Use Display Cover Kit		80850042

## 4.6 Accessories

### Description

#### Calibration Masses - ASTM Class 1 Tolerance:

20 g	49024-11	80780022
50 g	49054-11	80730028
100 g	49015-11	80780020
200 g	49025-11	80780023
500 g	49055-11	80780029
1 kg	49016-11	80780021
2 kg	49026-11	80780024
4 kg	49046-11	80780027
Security Device	470004-01	80850043
Density Determination Kit	470007-01	80850045
Auxiliary Display Kit (Table Mount)	470009-01	80850048
RS232 Interface Cable, Blunt end (user defined)	AS017-01	80850013
RS232 Interface Cable, IBM® - PC 25 Pin	AS017-02	80850014
RS232 Interface Cable, (connects impact printer)		80500570
RS232 Interface Cable, IBM® - PC 9 Pin	AS017-09	80850015
RS232 Interface Cable, Apple® IIGS/Macintosh	AS017-10	80850072
Printer		SF42
Printer Cable		80500570

# 5. TECHNICAL DATA

## 5.1 RS232 Commands

Command Character	Description												
<b>C</b>	Begin span calibration												
<b>xD</b>	Set 1 second print delay (set x = 0 for OFF, or x = 1 for ON)												
<b>PM</b>	Application mode.												
<b>xFL</b>	Set Averaging Filter Level 1= Low, 2= Medium, 3= High												
<b>L</b>	Begin linearity calibration												
<b>P</b>	Print displayed weight (stable or unstable) <table border="1" style="display: inline-table; vertical-align: middle;"> <tr> <td>Field:</td> <td>Weight</td> <td>Unit</td> <td>Stab</td> <td>CR</td> <td>LF</td> </tr> <tr> <td>Length:</td> <td>Max 9</td> <td>5</td> <td>1</td> <td>1</td> <td>1</td> </tr> </table>	Field:	Weight	Unit	Stab	CR	LF	Length:	Max 9	5	1	1	1
Field:	Weight	Unit	Stab	CR	LF								
Length:	Max 9	5	1	1	1								
<b>T</b>	Same as pressing Tare key.												
<b>PV</b>	Version: print name, software revision and LFT ON (if LFT is set ON)												
<b>xAL</b>	Set Auto-Zero level to x. x = 0 for OFF, x = 1 for 0.5d, x=2 for 1.0d, x=3 for 2.0d, x=4 for 5.0d.												
<b>Esc R</b>	Resets Setup and Print menus to factory defaults												
<b>On</b>	Turns balance on												
<b>Off</b>	Turns balance off												
<b>x%</b>	Set % reference weight (x) in current unit												
<b>x#</b>	Set PC reference weight (x) in current unit												
<b>P#</b>	Print PC reference weight												
<b>P%</b>	Print percent reference weight												
<b>xM</b>	Set current Application mode to x. x = 1 for Weighing, x = 2 for Parts Counting, x = 3 for Animal Weighing, x = 4 for Percent Weighing, x = 5 for Check Weighing, x = 6 for G/N/T, x = 7 for Filling												
<b>xAW</b>	Set Animal Weigh Level to x. x = 1 for LOW, x = 2 for MEDIUM, x = 3 for HIGH.												
<b>xAM</b>	Set animal mode. Where x is 1=Manual, 2=Semi and 3=Auto												
<b>SAW</b>	Start Animal cycle.												
<b>xT</b>	Download Tare value in current unit. Sending OT clears tare.												
<b>PID</b>	Print current user ID string												
<b>xID</b>	Program user ID string. 1-8 characters												
<b>AC</b>	Abort calibration												
<b>xUC</b>	Set user defined weight												
<b>UC</b>	Initiate user calibration												
<b>IC</b>	Initiate internal calibration												
<b>PTIME</b>	Print current time												
<b>mm/dd/yyDATE</b>	Set date												
<b>hh:mm:ssTIME</b>	Set time												
<b>PDATE</b>	Print current date												

## 5.2 Specifications

### Admissible Ambient Conditions

	Use only in closed rooms
Ambient Temperature range:	5 °C to 40 °C
Atmospheric humidity:	80% rh @ to 30 °C
Voltage fluctuations:	-15% +10%
Installation category:	II
Pollution degree:	2
Power supply voltage:	12 VAC, 50/60 Hz or 12 VDC, 1A

### Analytical Balances

Capacity (g)	62	110	210	100/210 *
Readability (mg)	0.1			0.1/1
Repeatability (Std. dev.) (mg)	0.1			0.1/0.5
Linearity (mg)	(±) 0.2			(±) 0.2/0.5
Weighing units ***	gram, milligram, ounce, ounce troy, carat, pennyweight, Hong Kong Tael, Singapore Tael, Taiwan Tael, mommes, grain, tical, Newton, custom			
Application modes	Weighing, Parts Counting, Animal Weighing, Check Weighing, Percent Weighing, Filling, Gross-Net-Tare Weighing, Differential Weighing, Formulation, Statistics, SQC, Density, Pipette			
Features	RS232 Port, Auxillary Display Port, GLP Protocol, Selectable Language, Display Text, Selectable Displayed Information Settings, Selectable Environmental Settings, Selectable Auto-Print Settings, Integral Weigh Below Hook, Contrast and Brightness Control, Protective In-Use cover			
Tare range	Full capacity by subtraction			
Stabilization time (s)	4			
Calibration	Internal			
Display Type	LCD Dot Matrix w/CCFL Backlight			
Display Size (in/cm)	2.5 x 4.7 / 6 x 12			
Operating temperature range:	10°C to 40° C / 50°F to 104°			
Power requirements	External Adapter, 100 -120 VAC 150mA, 220 - 240 VAC 100mA, 50/60 Hz Plug configuration for US, Euro, UK, Japan & Australia			
Draft shield (in/cm) (free height above platform)	10.2/25.9			
Pan size (in/cm)	3.5 / 9 diameter			
Dimensions (WxHxD) (in/cm)	8.5 x 13.5 x 14.5 / 21.5 x 35.5 x 37			
Net Weight (lb/kg)	14.8 / 6.7			

\* Moveable FineRange™

\*\*\* Units availability is country dependent.



## Precision Balances

Capacity (g)	210	410	610	100/410*	610	2100	4100	6100	1000/4100*	4100**	6100**	8100**
Readability (g)	0.001		0.001/0.01		0.01			0.01/0.1		0.1		
Repeatability (Std. dev.) (g)	0.0005	0.0015	0.0005/0.005		0.005		0.01	0.01/0.05		0.05		
Linearity (g)	(±)0.002		(±)0.002/0.005		(±)0.02		(±)0.04	(±)0.02/0.05		(±)0.1		
Weighing units***	gram, milligram, kilogram, pound, ounce, ounce troy, carat, pennyweight, Hong Kong Tael, Singapore Tael, Taiwan Tael, mommes, grain, tical, Newton, custom											
Application modes	Weighing, Parts Counting, Animal Weighing, Check Weighing, Percent Weighing, Filling, Gross-Net-Tare Weighing, Differential Weighing, Formulation, Statistics, SQC, Density, Pipette											
Features	RS232 Port, Auxiliary Display Port, GLP Protocol, Selectable Language, Display Text, Selectable Displayed Information Settings, Selectable Environmental Settings, Selectable Auto-Print Settings, Integral Weigh Below Hook, Contrast and Brightness Control, Protective In-Use cover											
Tare range	Full capacity by subtraction											
Stabilization time (s)	3											
Operating temperature range:	10°C to 40°C / 50°F to 104° F											
Calibration	Internal											
Power requirements	External Adapter, 100 -120 VAC 150mA, 220 - 240 VAC 100mA, 50/60 Hz											
	Plug configuration for US, Euro, UK, Japan & Australia											
Draft shield (in/cm) (free height above platform)	10.2/25.9				None							
Display Type	LCD Dot Matrix w/CCFL Backlight											
Display size (in/cm)	2.5 x 4.7 / 6 x 12											
Pan size (in/cm)	4.7/12 Dia.				6.8 x 6.8/17.2 x 17.2 w/windshield				6.8 x 6.8/ 17.2 x 17.2			
Dimensions (WxHxD) (in/cm)	8.5x13.5x14.5/21.5x35.5x37				8.5 x 4 x 14.5/21.5 x 10.1 x 37							
Net Weight (lb/kg)	14.8 / 6.7				10 / 4.5		15.5/7		10 / 4.5		15.5 / 7	

\* Moveable FineRange™

\*\*\* Units availability is country dependent.

## LIMITED WARRANTY

Ohaus products are warranted against defects in materials and workmanship from the date of delivery through the duration of the warranty period. During the warranty period Ohaus will repair, or, at its option, replace any component(s) that proves to be defective at no charge, provided that the product is returned, freight prepaid, to Ohaus.

This warranty does not apply if the product has been damaged by accident or misuse, exposed to radioactive or corrosive materials, has foreign material penetrating to the inside of the product, or as a result of service or modification by other than Ohaus. In lieu of a properly returned warranty registration card, the warranty period shall begin on the date of shipment to the authorized dealer. No other express or implied warranty is given by Ohaus Corporation. Ohaus Corporation shall not be liable for any consequential damages.

As warranty legislation differs from state to state and country to country, please contact Ohaus or your local Ohaus dealer for further details.

# Index

## A

AC Adapter Installation 6  
Accessories 50  
Additional Standards 4  
Admissible Ambient Conditions 52  
Admissible ambient conditions 52  
Ambient Temperature rang 52  
Analytical Balances 52  
Animal Weighing 17  
Application Modes 42  
Applications 12  
APW 14, 16  
Atmospheric humidity 52  
Audible Signal 42  
Auto Print 44  
Auto Tare 42  
Auto Zero 42  
AutoCal 40  
AutoCal Delta 40  
Average Piece Weight 13

## B

Balance ID 45  
Balance Location 5  
Balance Options 41  
Balance Preparation with Density Kit 32  
Balance Settings 40  
Baud Rate 44  
Brightness 42  
Buoyancy Sample Weighing 34

## C

Cal Test 41  
CALIBRATE 13, 20  
Calibrating from the Weighing Screen 7  
Calibration 45, 46, 40  
CALIBRATION MASSES 41  
Cannot access desired application 48  
Cannot display weight in desired unit 48  
Capacity 52  
CARE AND MAINTENANCE 48  
CHECK WEIGHING 20  
Check Weighing 20  
Check Weighing Mode 27  
Cleaning 48  
Connecting Power and Communications 6  
Contrast 41  
Cord Set 50  
Custom Unit (Cst) 43

## D

Data Bits 44  
Date 41  
Date & Time 45

Date Format 41  
Declaration of Conformity 3  
Defining Tolerances 30  
Density 31  
Density Determination Kit 50, 31  
Description 3  
Differential Weighing 23  
Display Date/Time 41

## E

Emission and Immunity 4  
Error Codes List 49  
Error message display 48  
Example of Sealing Method 47  
EXPONENTS 44

## F

Factory Reset 46  
Features 3  
FILLING 21  
Filling 21  
Filling Mode 27  
FILTER 18  
Filter Level 42  
Formulation 25

## G

G/N/T WEIGHING 22  
Global Part No. 50  
GLP Print Options 45, 44  
Gross / Net / Tare Weighing 22, 23, 25, 26, 29

## H

Hardware 6  
Hardware Lockswitch 47

## I

In-Use Display Cover Kit 50  
Incorrect calibration 48  
Incorrect weight reading 48  
Initial Calibration 7  
INSTALLATION 3  
Installation category 52  
Installing Components 4  
Interface 44  
Internal Calibration 40  
INTRODUCTION 3

## L

Languages 41  
LCD Display 9  
Lead Seal 47

# Index

Legal for Trade 42  
Leveling the Balance 5  
LFT DEFAULT TABLE 47  
LFT Legal for Trade 47  
Library 45  
Library Name: 24  
LIMITED WARRANTY 53  
Linearity Calibration 41  
Lockout 46

## M

Menu 11  
Menu Structure 11

## N

Navigation 11  
NEW COUNT 13  
New Count Key 14  
NEW REF 19  
Numeric Data 44

## O

OPERATION 8  
Output Formats 6  
Overview of Controls 8  
Overview of Display Indicator 10

## P

Parity Bit 44  
PARTS COUNTING 13  
Parts Counting 13  
PARTS COUNTING-CHECK 15  
PARTS COUNTING-FILL 16  
PC CHECK 15  
PC FILLING 16  
PERCENT WEIGHING 19  
Percent Weighing 19  
Pipette Calibration 37  
Platform Installation 4  
Pollution degree 52  
Porous Material Density Determinations 36  
Power On/Off 11  
Power Pack 50  
Power supply voltage 52  
Precision Balances 53  
Print Interval 44  
Print Options 44  
Printer 50  
Printer Cable 50  
Printing Data 47  
Project Name 45

## R

Readout 42  
Rear of Balance 6  
REFERENCE 20  
Reference 45  
Replacement Parts 50  
Replacement parts 50  
RS232 Commands 51  
RS232 Interface 6  
RS232 Interface Cable 50  
RS232 interface not working 48

## S

Safety Precautions 3  
SAMPLE PRINTOUT 47  
SAMPLE SIZE 13  
SAMPLE SIZE/APW 14, 16, 17  
Sample Weighing in Air 34  
Sample Weighing in Liquid 34  
SCIENTIFIC NOTATION 43  
Sealing Screw 47  
Sealing the Balance 47  
Security Device 50  
Selecting the Location 5  
Service Information 50  
SETUP 13  
Size/APW Key 14  
Span Calibration 40  
Specifications 52  
Stability Level 42  
Stabilization 11  
Stable Data 44  
Statistical Quality Control 29  
Statistics 26  
Stop Bits 44  
Switch Plate 47

## T

TECHNICAL DATA 51  
Time 41  
Time Format 41  
Troubleshooting 48  
Turning on the Balance 11

## U

U.S. Part No. 50  
Unable to change menu settings 48  
Unit will not turn on 48  
Units 42  
Unpacking 3  
Unstable readings 48

# Index

User Calibration 41  
User Calibration Weight 41  
User Name 45

## V

Voltage fluctuations 52

## W

Weigh Below Preparation 4  
Weighing 12  
Weighing with a Container 12  
Weighing/Animal Modes 27  
Windshield Installation 4

## Z

Zero the balance 12







Ohaus Corporation  
19A Chapin Road,  
P.O. Box 2033  
Pine Brook, NJ 07058, USA  
Tel: (973) 377-9000,  
Fax: (973) 593-0359

With offices worldwide.  
[www.ohaus.com](http://www.ohaus.com)



PN 80251000 A © Ohaus Corporation 2003 all rights reserved.